

Pennsylvania Driver's Manual

SPEED
LIMIT
35



Sharing the Road with Motorcycles and Vehicles

Today's motorcycle riders are friends, relatives and neighbors. The motorcyclist has the same rights and responsibilities on the roadway as drivers of other vehicles. Motorists should recognize this and not attempt to crowd motorcycles or take the right-of-way from motorcyclists.

Approximately 4,000 motorcycle crashes occur on Pennsylvania roads each year. Half of these involved a crash between a motorcycle and another type of vehicle. And almost two-thirds of these crashes are caused not by the motorcyclist but by the driver of the other vehicle.

Look out for motorcyclists Be aware that motorcycles are small and may be difficult to see. Motorcycles have a much smaller profile than other vehicles, which can make it more difficult to judge the speed and distance of an approaching motorcycle.

Anticipate a motorcyclist's maneuver. Road conditions, which are minor annoyances to vehicle drivers, pose major hazards to motorcyclists.

Allow more following distance Leave three or four seconds when following a motorcycle, so the motorcyclist has enough time to maneuver or stop in an emergency. In dry conditions, motorcycles can stop more quickly than a vehicle.

Signal your intentions Before changing lanes or merging with traffic, signal your intentions allowing the motorcyclist to anticipate traffic flow and find a safe lane position.

Don't be fooled by a flashing turn signal on a motorcycle – motorcycle signals usually are not self canceling and riders sometimes forget to turn them off. Wait to be sure the motorcycle is going to turn before you proceed.

Respect a motorcycle A motorcycle is a full-size vehicle with the same privileges as any vehicle on the roadway. Allow a motorcyclist a full lane width. Although it may seem as though there is enough room in the traffic lane for a vehicle and a motorcycle, remember the motorcycle needs room to maneuver safely. Do not share the lane.



CRASHES ARE MOST LIKELY TO OCCUR IN THESE HIGH-RISK SITUATIONS:

Left turns

Approximately one-half of all motorcycle crashes involve another motor vehicle. Nearly 40 percent were caused by the other vehicle turning left in front of the motorcyclist.

Vehicle's blind spot

Remember, motorcyclists are often hidden in a vehicle's blind spot or missed in a quick look due to their smaller size. Always make a visual check for motorcycles by checking mirrors and blind spots before entering or leaving a lane of traffic and at intersections.

Hazardous road conditions

Motorcyclists may change speed or adjust their position within a lane suddenly in reaction to road and traffic conditions such as potholes, gravel, wet or slippery surfaces, pavement seams, railroad crossings and grooved pavement.

Weather conditions

When the road surface is wet or icy, motorcyclists' braking and handling abilities are impaired.

Strong winds

A strong gust of wind can move a motorcycle across an entire lane if the rider is not prepared for it. Wind gusts from large trucks in the other lane can be a real hazard.

Large vehicles

A large vehicle, such as a van or truck, can block a motorcycle from a driver's view. The motorcyclist may seem to suddenly appear from nowhere.

Sharing the roadway is a good indication motorists and motorcycles both recognize the importance of cooperation. By curbing aggressive behavior and operating vehicles in accordance with common sense, courtesy and the law, motorists and motorcyclists can ride together on the road.

INTRODUCTION

This manual is designed to help you become a safe driver. **It presents many of Pennsylvania's laws governing driving. It should be used as a general guide to the laws but not as a substitute for the Pennsylvania Vehicle Code, which contains the laws affecting Pennsylvania's drivers and vehicles. It should also be noted that the information contained in this manual is subject to change.**

The purpose of this manual is to prepare you to take the driver's examination and to obtain a Pennsylvania driver's license. However, the rules of the road and traffic operation principles presented in this manual apply to the three types of vehicles recognized by Pennsylvania law: bicycles, horse-drawn vehicles and motor vehicles. For example, all bicyclists, just like motorists, are required to stop at red lights.

If you are learning to drive, this manual will give you all the information you need to study for the driver's examination. If you already have a Pennsylvania driver's license, you can use this manual to review some of the rules of the road you may have forgotten or to learn about some of the rules that may be new or have changed since you received your license.

IMPORTANT

Before taking your Knowledge Test, you must complete the Non-Commercial Learner's Permit Application (DL-180).
If you are under the age of 18, your parent or guardian must complete the Parent or Guardian Consent Form (DL-180TD)

Both forms can be found on our website at www.dmv.pa.gov under the Forms and Publications link at the top of the page

Driving is a privilege and not a right. This privilege comes with many responsibilities. One very important responsibility is that you never mix drinking and driving.

For the days and hours of operation of a Driver License Center nearest you, to download the most current forms, publications, and fact sheets or to access PennDOT's online services, including scheduling your On-the-Road Skills Test, visit PennDOT's Driver and Vehicle Services website at www.dmv.pa.gov

Please read this manual carefully, learn and practice the rules of the road in order to become a safe driver and enjoy your driving privilege in our beautiful state.

THIS PUBLICATION IS NOT FOR SALE

Table of Contents

Chapter 1 – Non-Commercial	
Learner's Permit Information 1	Special Circumstances and Emergencies 54
Applying for a Learner's Permit 1	Work Zones 54
Organ Donor Designation 2	Railroad Crossings 55
Veterans Designation 2	Sharing the Road with Pedestrians, Bicyclists, Motorcyclists/Moped Drivers 55
Social Security Number Information 3	Sharing the Road with Trucks and Buses 56
Pennsylvania Vision Standards 3	School Buses 58
Who Needs a Pennsylvania Driver's License . 3	Emergency Vehicles/Situations 59
Junior Learner's Permit Information 3	Move Over Law 59
Junior Driver's License Information 3	Horse-Drawn Vehicles & Horseback Riders . 59
What Class of Driver's License Do You Need . . 4	Passengers in an Open-Bed Truck 59
Classes of Driver's Licenses 4	Snow Plows 60
Tests 5	Dealing with Road Rage 60
Knowledge Test 5	Dealing with Driving Emergencies 60
Road Test 5	Funeral Procession 64
Chapter 2 – Signals, Signs and	Chapter 3 Review Questions 65
Pavement Markings 7	Chapter 3 Review Answers 78
Signals 7	Chapter 4 – Driving
Red, Yellow and Green Traffic Lights and Arrows 7	Record Information 79
Flashing Signals 8	Pennsylvania's Point System 79
Non-Functioning Traffic Lights 8	What To Do If You Are Stopped By Police . . 80
Ramp-Metering Signals 8	Crashes 81
Lane Use Control Signals 8	Fleeing or Eluding Police 81
Pedestrian Signals 9	Driving Under the Influence of Alcohol or a Controlled Substance 81
School Zone Signals 9	Underage Drinking 84
Railroad Crossing Signals 9	Driver's License Compact (DLC) 84
Signs 10	Chapter 4 Review Questions 86
Regulatory Signs 10	Chapter 4 Review Answers 88
Warning Signs 13	Chapter 5 – Laws and Related Issues 89
Guide Signs 19	Required Notification for Change in Name or Address 89
Pavement Markings 22	Seat Belt Law 89
Chapter 2 Review Questions 23	Child Restraint Law 90
Chapter 2 Review Answers 30	Safety Tips for Children and Pets 90
Chapter 3 – Learning to Drive 31	Air Bag Safety Information 91
Choosing Safety First 31	Americans with Disabilities Act (ADA) 91
Vehicle Checks: Preparing to Drive 31	Parking Areas for Persons with Disabilities 92
Driver Factors 32	Anti-Littering Law 92
Inattention 32	Vehicle Safety and Emissions Inspection 92
Health Factors 33	Safe Passing (bicycles) 92
Alcohol and Driving 33	Texting 93
Drugs and Driving 34	Obedience to Traffic-Control Devices Warning of Hazardous Conditions Law 93
Everyday Driving Skills 35	Chapter 6 – References 94
Managing Space 35	Road Test and Special Point Examination
Managing Speed 38	Appointments 94
Turning, Merging and Passing 45	Non-CDL Third Party Testing Program 94
Negotiating Intersections 48	Departmental Forms and Publications 94
Negotiating Curves 51	Statewide and County Maps 94
Negotiating Highways and Interchanges 52	Other Information 94
Parking 52	511PA 94
Parallel Parking Tips 53	Carbon Monoxide Poisoning 95

CHAPTER 1: NON-COMMERCIAL LEARNER'S PERMIT INFORMATION

This chapter will provide the information you need to know about obtaining a Pennsylvania learner's permit. The areas addressed include:

- Applying for a Learner's Permit
- Tests

APPLYING FOR A LEARNER'S PERMIT

You must obtain a learner's permit before you operate a motor vehicle in Pennsylvania. You will need to take and pass the Vision, Knowledge and Road Tests to get your driver's license. The Non-Commercial Learner's Permit Application (DL-180) is valid for one (1) year from the date of your physical examination; however, the physical examination date may not be more than six (6) months prior to your 16th birthday.

When you are 16 years of age or older, please follow the steps listed below in order to get your non-commercial learner's permit. You cannot apply for your permit before your 16th birthday.

1. Complete the Non-Commercial Learner's Permit Application (DL-180) found on our website at www.dmv.pa.gov under the Forms and Publications link at the top of the page.
2. Your health care provider must complete the back of the Non-Commercial Learner's Permit Application (DL-180). The form must be completed no earlier than six (6) months prior to your 16th birthday. All information must be completed.
3. If the Driver License Examiner cannot determine whether the information on the Non-Commercial Learner's Permit Application (DL-180) meets medical standards, your learner's permit may be delayed. You may be required to undergo additional medical examinations. If you have a condition that seriously impairs your ability to drive, you may be required to get a dual control learner's permit and learn to drive with a certified instructor.
4. If you are under 18 years of age, your parent, guardian, person in loco parentis, or spouse who is 18 years of age or older must complete the Parent or Guardian Consent Form (DL-180TD) also found on our website at www.dmv.pa.gov under the Forms and Publications link at the top of the page. **If the parent, guardian, person in loco parentis, or spouse who is 18 years of age or older cannot accompany the applicant, the DL-180TD must be signed by the parent, guardian, person in loco parentis, or spouse who is 18 years of age or older in the presence of a notary.** Proper identification is required and if last names are different, verification of relationship is needed. If you are over 18 years of age, you must present two (2) proofs of residency:
 - Current Utility Bills (water, gas, electric, cable, etc.).
 - Tax Records.
 - Lease Agreements.
 - W-2 Form.
 - Current Weapons Permit (U.S. Citizens only).
 - Mortgage Documents.

After studying the manual and following the steps listed above, **bring the items listed below to the Driver License Center** when you are ready to take your Knowledge Test:

- Your completed Non-Commercial Learner's Permit Application (DL-180). **Do not mail this form.** If under 18 years of age, also bring your completed Parent or Guardian Consent Form (DL-180TD).
- Proof of date of birth and identification. These documents must be originals (photocopies will **not** be accepted).
- Your Social Security card.
- Applicable fee. (Note: Please refer to back of form for acceptable form(s) of payment)

Please Note: Forms of identification that may be used to prove your date of birth are listed on the back of the Non-Commercial Learner's Permit Application (DL-180) along with the fees.

If you do not have your vision tested by your HCP or optometrist, your vision will be tested at the driver license center. If you wear glasses or contact lenses, please bring them with you. You will then take the Knowledge Test

on signs, laws, driving rules and safe practices described later in this manual. After passing the Knowledge Test, the examiner will give you a learner's permit, which is valid for one (1) year. When you receive your learner's permit, you may begin to practice driving. PennDOT recommends young drivers schedule their road test at this time as long as the testing date is not before the eligibility date printed on your learner's permit.

If you are under the age of 18, you are required to complete at least 65 hours of behind-the-wheel skill-building including no less than 10 hours of nighttime driving and five (5) hours of bad weather driving before taking your Road Test. This training will help teach you the skills necessary to become a good, safe driver.

REMEMBER: A licensed driver who is at least 21 years of age or a parent, guardian, person in loco parentis, or spouse who is 18 years of age or older and holds a driver's license must ride with you in the front seat of your vehicle at all times. In addition, drivers under the age of 18 cannot have more passengers in the vehicle than the number of seat belts.

After you have waited the mandatory six (6) months from your permit issue date and have a signed certificate of completion for the 65 hours of skill-building including no less than 10 hours of nighttime driving and five (5) hours of bad weather driving, you may take your Road Test. If your learner's permit expires or if you do not pass your road test after three (3) tries, you may obtain a Non-Commercial Learner's Permit Application to Add/Extend/Replace/Change/Correct (DL-31).

If you are using your learner's permit for driving outside the Commonwealth of Pennsylvania, please check with your insurance company and the other state's Department of Transportation to make sure your learner's permit is considered valid.

If any information on your learner's permit is not correct, bring proof of the correct information to the examiner when you come to the Driver License Center for testing.

If you fail the Knowledge Test, the examiner will return the Non-Commercial Learner's Permit Application (DL-180) and your Parent or Guardian Consent Form (DL-180TD) to you. You may take the Knowledge Test only one time on any day regardless of test location. Keep your forms in a safe place since you must bring them with you when you are tested again.

ORGAN DONOR DESIGNATION

Each time you renew your Pennsylvania driver's license, you will be asked if you want the "ORGAN DONOR" designation on your driver's license. Please decide before going to the Photo License Center. The words "ORGAN DONOR" will appear on your driver's license when you say, "Yes" to being designated as an organ donor at the Photo License Center.

Applicants under 18 years of age may request and obtain the organ donor designation on their driver's license; however, they must have written consent from a parent, guardian, person in loco parentis, or spouse who is 18 years of age or older. They may give consent by checking the appropriate block on the Parent or Guardian Consent Form (DL-180TD). For information on Organ and Tissue Donation, contact 1-877-DONOR-PA.

You can also add the "ORGAN DONOR" designation to your driver record via our website at www.dmv.pa.gov. Through this service channel, you will be given the opportunity to print a card to carry with your driver's license.

ORGAN DONATION AWARENESS TRUST FUND (ODTF)

You have the opportunity to donate to the Governor Robert P. Casey Memorial Organ & Tissue Donation Awareness Trust Fund. The trust fund will create funding to support the various organ donation programs across the commonwealth and provide for public information concerning these programs. Make a check mark on your driver's license form, if you wish to contribute to this fund. The contribution is added to the driver's license fee and must be included in your payment when you send your form to PennDOT.

VETERANS DESIGNATION

You have the opportunity to add the veterans designation to your driver's license, which clearly indicates you are a veteran of the United States Armed Forces. To qualify, you must have served in the United States Armed Forces, including a reserve component or the National Guard, and have been discharged or released from such service under conditions other than dishonorable.

VETERANS' TRUST FUND (VTF)

You have the opportunity to make a tax deductible contribution to the VTF. Your contribution will help support

programs and projects for Pennsylvania veterans and their families. Since this additional contribution is not part of the fee, please add the donated amount to your payment. Also, please check the proper block on the form to ensure your contribution is handled properly.

SOCIAL SECURITY NUMBER INFORMATION

The Department is required by law to obtain your Social Security number, height and eye color under the provisions of Section 1510(a) and/or 1609(a)(4) of the Pennsylvania Vehicle Code. The information will be used as identifying information in an attempt to minimize driver's license fraud. Your Social Security number is not part of your public driver's record. Federal law permits the use of the Social Security number by state licensing officials for purposes of identification. Your Social Security number will not be printed on your learner's permit or driver's license.

PENNSYLVANIA VISION STANDARDS

You may have poor vision in either eye and still be able to obtain a driver's license; however, you may be required to wear glasses or contact lenses, be restricted to daylight driving or be allowed to operate only vehicles equipped with side mirrors.

If your vision fails to meet the vision standards, the examiner will give you a Report of Eye Examination Form (DL-102). You should have an optometrist, ophthalmologist or family physician test your vision and complete this form. When the form is completed, you may return to the Driver License Center to continue testing.

WHO NEEDS A PENNSYLVANIA DRIVER'S LICENSE?

- Individuals who possess a valid foreign driver's license from their country are authorized to drive in Pennsylvania for up to one year from their date of entry into the United States, or upon expiration of their foreign license, whichever comes first. International driving permits are strongly recommended, but not required. Reciprocity agreements exist with the countries of France, Germany, Korea and Taiwan allowing for the transfer of a valid non-commercial driver's license without Road or Knowledge testing; however, a Vision Test will be administered. (Transfer of a driver's license from Puerto Rico, France, or Germany cannot be completed the same day.)
- People living in Pennsylvania who are at least 16 years of age and want to drive a motor vehicle.
- People who just moved into Pennsylvania and are establishing Pennsylvania residency - if you hold a valid driver's license from another state or Canada, you must get a Pennsylvania driver's license within 60 days after moving to Pennsylvania and surrender your out-of-state driver's license.
- People in the United States Armed Forces whose legal address is in Pennsylvania - this includes members of the reserve components stationed in Pennsylvania, who must get a driver's license to operate a non-military vehicle.

JUNIOR LEARNER'S PERMIT INFORMATION

Your learner's permit will be valid for one (1) year from the issue date printed on your initial learner's permit. During this time, there are certain limitations on your driving privilege if you are under 18 years of age. They are:

- You may only drive under the supervision of a licensed driver who is at least 21 years of age or a parent, guardian, person in loco parentis, or spouse who is 18 years of age or older and holds a driver's license. The supervising driver must sit in the front seat.
- You may not carry more passengers than seat belts available in the vehicle you are driving.

JUNIOR DRIVER'S LICENSE INFORMATION

Like the junior learner's permit, there are some limitations to the junior driver's license. They are:

- You may not drive between the hours of 11 p.m. and 5 a.m., unless your parent, guardian, person in loco parentis, or spouse who is 18 years of age or older is with you.

However, you may drive between 11 p.m. and 5 a.m., if you are involved in public or charitable service, a member of a volunteer fire company or employed during those hours. In these cases, you must carry a notarized affidavit or certificate of authorization from your employer, supervisor or fire chief indicating your probable schedule of activities. This notarized affidavit should be kept with your driver's license.

- You may not carry more passengers than seat belts available in the vehicle you are driving.

- You may not carry more than one (1) passenger under the age of 18 who is not an immediate family member unless a parent, guardian, person in loco parentis, or spouse who is 18 years of age or older is in the vehicle with you. After the first six (6) months of driving on a junior license, the limit is increased to no more than three (3) passengers under the age of 18 who are not immediate family members unless a parent, guardian, person in loco parentis, or spouse who is 18 years of age or older is in the vehicle with you. The increased limit does not apply to any junior driver who has ever been involved in a crash in which you were partially or fully responsible or who is convicted of any driving violation.
- You will receive a mandatory 90-day suspension if you accumulate six (6) or more points or are convicted of driving 26 miles per hour (mph) or more over the posted speed limit.
- You may get a regular driver's license after you have held a junior driver's license for one (1) year, if you meet the following conditions:
 - Have passed a driver training course approved by the PA Department of Education.
 - Have **not** been involved in a crash for which you are partially or fully responsible for one (1) year.
 - Have **not** been convicted of any violation of the Pennsylvania Vehicle Code for one (1) year.
 - Have the consent of your parent, guardian, person in loco parentis, or spouse who is at least 18 years of age.

If you meet these requirements, you may apply for a regular driver's license by submitting an Application for Change from a Junior Driver's License to a Regular Non-Commercial Driver's License (DL-59). Your junior driver's license will automatically become a regular driver's license when you turn 18 years of age.

WHAT CLASS OF DRIVER'S LICENSE DO YOU NEED?

In Pennsylvania, driver's licenses are issued specifically for the class and type of vehicle you operate. Therefore, the class of driver's license you should have depends specifically upon the type of vehicle you operate. Generally speaking, the majority of applicants for a Pennsylvania driver's license will be operators of regular passenger vehicles, pick-up trucks or vans. **This manual is designed to provide the information you need to get a non-commercial Class C driver's license, which is the class that covers these types of vehicles.**

CLASSES OF DRIVER'S LICENSES

- **CLASS A (minimum age 18):** Required to operate any combination of vehicles with a gross weight rating of 26,001 pounds or more, where the vehicle(s) being towed is/are in excess of 10,000 pounds. Example: Recreational Vehicle, when the towing vehicle is rated at 11,000 pounds and the vehicle towed is rated at 15,500 pounds (total combination weight of 26,500 pounds).
- **CLASS B (minimum age 18):** Required to operate any single vehicle rated in excess of 26,000 pounds. Example: Motor homes rated at 26,001 pounds or more.
- **CLASS C (minimum age 16):** A Class C driver's license will be issued to persons 16 years of age or older, who have demonstrated their qualifications to operate any vehicles, except those requiring a Class M qualification, and who do not meet the definitions of Class A or Class B. Any firefighter or member of a rescue or emergency squad who is the holder of a Class C driver's license and who has a certificate of authorization from a fire chief or head of the rescue or emergency squad will be authorized to operate any fire or emergency vehicle registered to that fire department, rescue or emergency squad or municipality. The holder of a Class C license is authorized to drive a motor-driven cycle with an automatic transmission and cylinder capacity of 50 CC's or less or a three-wheeled motorcycle with an enclosed cab.
- **CLASS M (minimum age 16):** A Class M driver's license will be issued to those persons 16 years of age or older who have demonstrated their ability to operate a motorcycle or motor-driven cycle. If a person is qualified to operate only a motorcycle or motor-driven cycle, they will be issued a Class M driver's license. If you test on a motor-driven cycle, an "8" restriction will appear on our driver's license. This restriction prohibits you from operating a motorcycle. If you test on a motorcycle with more than two (2) wheels, a "9" restriction will appear on your driver's license. This restriction prohibits you from operating a two-wheeled motorcycle. Please refer to the Pennsylvania Motorcycle Operator's manual (PUB 147) or the Mopeds, Motor-Driver Cycles and Motorcycles Fact Sheet located on PennDOT's Driver and Vehicles Services website in the Motorcycle Information Center.

- **COMMERCIAL CLASS A, B or C:** Drivers who need a commercial driver's license should obtain the Pennsylvania Commercial Driver's Manual (PUB 223), which contains detailed information necessary to prepare for the tests. This manual is available on PennDOT's Driver and Vehicle Services website in the Commercial Driver Information Center.

TESTS

KNOWLEDGE TEST

The Knowledge Test will measure your knowledge of traffic signs, Pennsylvania's driving laws and safe driving practices. The Knowledge Test can be given in both written and audio format in the following languages Spanish, Arabic, Chinese (Mandarin), French, Hindi, Korean, Russian, Ukrainian, Vietnamese, English, Burmese, Greek, Italian, Japanese, Nepali, Polish, Somali, and Urdu languages upon request, at all Driver License Centers across the commonwealth. If you fail the Knowledge Test, you will be permitted to retake the test the following business day. **This test needs to be successfully completed before you can receive a valid learner's permit.**

The Knowledge Test consists of 18 multiple choice questions. You must answer 15 questions correctly to pass the test. Possible driving situations are available on our website (www.dmv.pa.gov/Driver-Services/Teen-Drivers/Pages/default.aspx#.VpAM5aMo670) under the Teen Driver Information Center and the online version of this manual under the Teen Driver Information Center. You may download the PA driver's license practice test app by using the QR codes to the right.



Download for your Android™ directly from Google Play:
<https://play.google.com/store/apps/details?id=com.nicus.a.pdt>

PA Driver's License Practice Test App



Download for your iOS Device™ directly from the App Store:
<https://itunes.apple.com/us/app/pa-drivers-license-practice/id925842053?mt=8>

ROAD TEST

If you are under the age of 18, we allow our young drivers to schedule their skills test up to six (6) months in advance. Young drivers are encouraged to plan ahead and schedule as soon as possible. We recommend that our young drivers take advantage of this opportunity.

Appointments must be made to take the Non-Commercial Road Test. You may schedule your Road Test via the Driver and Vehicle Services website at www.dmv.pa.gov. If you do not have access to the Internet, you can schedule your driver's test by calling 1-800-423-5542.

Additionally, PennDOT has certified third-party businesses to administer the skills test for a market-driven fee. All third-party examiners are PennDOT-certified and the test is identical to the test that you would take at a PennDOT driver license center. For a list of participating businesses in your area, visit www.dmv.pa.gov.

You will need to present the following items to the examiner prior to taking your Road Test:

(All items must be valid and for the vehicle you are using for your Road Test.)

- Your valid learner's permit.
- A signed parent or guardian certification form (DL-180C) for 65 hours of behind-the-wheel training, if you are under the age of 18.
- The valid registration card for the vehicle you plan to drive for the Road Test.
- Proof that the vehicle is currently insured.
- The valid driver's license of the person, who is at least 21 years of age or a parent, guardian, person in loco parentis, or spouse who is 18 years of age or older, accompanying you to the Driver License Center.

If you do not bring the original documents (not copies) listed above, you will not be given the test.

Before the test begins, a driver license examiner will check to see that your vehicle has a valid registration card, current insurance, valid state inspection sticker and, if required, a valid emissions sticker. The lights, horn, brakes, windshield wipers, turn signals, mirrors, doors, seats and tires on your vehicle will also be checked to make certain they operate properly and meet safety standards. If it is determined any part of your vehicle is unsafe or does not meet state inspection requirements, you will not be allowed to take the Road Test. If your vehicle is equipped with seat belts, make sure they are clean and ready for use. You and the examiner will be required to wear them during the Road Test.

If your vehicle passes this inspection, the examiner will test you to see if you can drive safely.

You will fail the Road Test if you drive dangerously, violate the law, cause a crash, do not follow the examiner's instructions or make too many driving errors.

The examiner may ask you to do the following prior to taking the Road Test:

- **Vehicle Controls:** Operate horn, lights (parking lights, high and low beam headlights, turn signals), windshield wipers, parking (emergency) brake, 4-way flashers (hazard lights), defroster, etc. Failure to properly operate any of the vehicle controls will result in a failure of the Road Test.
- **Parallel Park:** Park your vehicle midway between two (2) uprights in a space that is 24 feet long and eight (8) feet wide. Your entire vehicle must be completely inside the space, and you cannot make contact with any of the uprights to the rear or front of your vehicle, cross over the painted line, or go up onto or over the curb. You have one (1) attempt to successfully park your vehicle using no more than three (3) adjustments.

Note: Vehicles equipped with Advanced Parking Guidance Systems (self parking vehicles) can be used for testing; however, the self parking feature must be turned off and is not permitted to be activated during the Road Test.

The examiner will be your only passenger during the Road Test. When the Road Test begins, you will be told where to drive and what maneuvers to make. **Close attention will be paid to the way you approach and obey warning signs, stop signs and traffic lights.** The examiner will note how you control your vehicle, use turn signals to communicate with other drivers or use any other vehicle controls that may become necessary during the test.

IF YOU PASS THE ROAD TEST AT A PENNDOT DRIVER'S LICENSE CENTER, you will receive your driver's license at that time.

YOU WILL FAIL THE ROAD TEST FOR:

(These are some examples of possible reasons for failing the Road Test)

- Inability to operate any vehicle controls
- Making errors in safe driving practices
- Causing a crash
- Violating any traffic laws (e.g., failing to obey a stop sign)
- Failing to follow instructions given by the examiner
- Not using turn signals
- Driving dangerously or recklessly

If you are under the age of 18 and fail the Road Test, Pennsylvania law requires you to wait seven (7) days before you can retake the Road Test. This delay in retaking the test will give you time to practice and to improve your driving skills. You have three (3) chances with each learner's permit to pass the Road Test before the expiration date of the learner's permit. After the third failure, you must reapply to extend your learner's permit.

If you do not pass your Road Test after three (3) tries or if your learner's permit expires, you may obtain an Application to Add/Extend/Replace/Change/Correct Non-Commercial Learner's Permit (DL-31). If you have not taken or successfully completed the Road Test within three (3) years of your physical examination date, you must start over with another Non-Commercial Learner's Permit Application (DL-180) and retake the Knowledge Test.

CHAPTER 2: SIGNALS, SIGNS AND PAVEMENT MARKINGS

This chapter provides the information you need to know about Pennsylvania roadways. It covers:

- Signals
- Signs
- Pavement Markings

SIGNALS

Traffic signals are installed at intersections to control the movement of vehicles and pedestrians. Traffic signals are arranged in either vertical lines or horizontal lines. When they are arranged vertically, red is always on top and green on the bottom. When they are arranged horizontally, red is always on the left and green on the right.

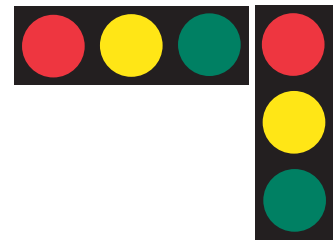

RED, YELLOW AND GREEN TRAFFIC LIGHTS AND ARROWS



When there is a **STEADY RED LIGHT**, you must stop before crossing the marked stop line or crosswalk. If you do not see any lines, stop before entering the intersection. Wait for a green light before you start.

You may turn right while the light is red, unless a **NO TURN ON RED** sign is posted at the intersection. You must first stop, check for and yield to pedestrians and other traffic.

You may also turn left after you stop at a red light, if you are in the left lane and are turning left from a one-way street onto another one-way street, unless a sign tells you not to turn. You must first stop and yield to pedestrians and other traffic.



A **STEADY YELLOW LIGHT** tells you a steady red light will soon appear. If you are driving toward an intersection and a yellow light appears, slow down and prepare to stop. If you are within the intersection or cannot stop safely before entering the intersection, continue through carefully.



A **STEADY GREEN LIGHT** means you may drive through the intersection, if the road is clear. You may also turn right or left unless a sign tells you not to; however, when turning, you must yield to other vehicles and pedestrians within the intersection.



A **STEADY RED ARROW** means you must stop and may not turn in the direction the arrow points. Wait for a Green Arrow or a Flashing Yellow Arrow before you start. The same turns-on-red that are allowed for a steady red signal are allowed for a steady red arrow.



A **STEADY YELLOW ARROW** means the movement permitted by the green arrow or the flashing yellow arrow is about to end and the signal will soon turn red. You should slow down and prepare to stop completely before entering the intersection. If you are within the intersection or cannot stop safely before entering the intersection, you may complete the turn begun on the preceding arrow with caution.



A **STEADY GREEN ARROW** means you may turn the way the arrow points. When you turn during the green arrow phase, your turn is "protected" because oncoming traffic is stopped by a red light. If the green arrow turns into a green light, you may still turn in that direction, but first yield to pedestrians and oncoming traffic.

FLASHING SIGNALS



A flashing red light has the same meaning as a **STOP** sign. You must come to a complete stop. Then, look both ways, and proceed only after the intersection is clear.



A flashing yellow light means **CAUTION**. Slow down, look and proceed with care.



A FLASHING YELLOW ARROW means you may turn in the direction of the arrow with caution, however, you must first yield to oncoming traffic and pedestrians. When you turn during the flashing yellow arrow phase, your turn is **NOT** protected; oncoming traffic will have a green light.

NON-FUNCTIONING TRAFFIC LIGHTS

A non-functioning traffic signal should be treated as though it were a four-way **STOP** sign.

RAMP-METERING SIGNALS

Some highway entrance ramps have traffic signals at the end of the ramp that alternate between steady green and steady red. Ramp metering signals are used to control the flow of traffic onto very congested highways and usually operate during peak rush hours. You must wait for the green signal before you enter the highway. On single-lane ramps, only one (1) car may enter the highway each time the light turns green. For multi-lane on ramps, there will be a ramp meter for each lane. **The green light does not protect your entrance onto the highway — you must still look for a safe gap in traffic to enter the highway.**

LANE USE CONTROL SIGNALS

Special signals may also be placed directly over lanes to control traffic. These are commonly used at toll booths, on bridges, tunnels and on multi-lane roads in cities where the direction of travel for a particular lane changes to ease the flow of traffic into or out of the city during peak rush hour. The following signals show how specific lanes of a street or highway should be used:



A steady downward green arrow over a traffic lane means you may use the lane.



A steady yellow "X" over a traffic lane means you must change lanes because the direction of travel for that lane is about to be reversed. Get ready to leave the lane safely.



A steady red "X" over a lane means you are not allowed to use the traffic lane.



A white steady, one-way left-turn arrow over a lane means you may only turn left, if you are in that lane.



A white steady, two-way left-turn arrow over a lane means you may only turn left, if you are in that lane, but the lane is shared by left-turning drivers approaching from the opposite direction.

PEDESTRIAN SIGNALS

Pedestrians must obey traffic and pedestrian signals. The pedestrian signals you must obey are the **WALK** and **DON'T WALK** lights or the lighted picture of a walking person (meaning walk) and an upraised hand (meaning don't walk). If there are no pedestrian signals at the intersection, pedestrians must obey the red, yellow and green traffic lights.

Sometimes pedestrians are not aware of their responsibilities at traffic and pedestrian signals. Be alert for pedestrians, who may not obey the signal. Always yield to pedestrians.



When a steady **WALK** or walking person comes on, start crossing, but be alert for turning vehicles that may not lawfully yield the right of way.



When the flashing **DON'T WALK** or flashing upraised hand begins:

- a. Finish crossing, if you are in the street.
- b. **Do not start to cross**, if you have not left the curb.



When the steady **DON'T WALK** message or steady upraised hand is displayed, do not cross.



Blind Pedestrians

When driving near a blind pedestrian who is carrying a white cane or walking with a guide dog, you must slow down, always yield the right-of-way and then proceed with caution. Be prepared to stop your vehicle in order to prevent injury or danger to the pedestrian.



SCHOOL ZONE SIGNALS

School zone signals are flashing yellow signals placed on the school zone speed limit signs. You must travel no faster than 15 mph when the yellow signals are flashing or during the time periods indicated on the sign. Exceeding the speed limit in a school zone will result in three (3) points on your driving record, and you will also be fined.

RAILROAD CROSSING SIGNALS

Drivers are alerted when approaching a railroad crossing by the railroad crossing sign. Railroad crossings should be approached with caution at all times. You should always look both ways and listen for any approaching trains or signals before proceeding across the railroad tracks.

You are required to stop at all railroad crossings when there is a signal of an approaching train. These signals include flashing red lights, a lowered crossing gate, a flagger signaling or a train's audible signal of warning. Do not move forward or attempt to go around any gate or ignore any signal of an approaching train. If there are no signals at the railroad crossing, you should slow down and prepare to stop, if you see or hear a train approaching.

Proceed with caution only after all signals are completed and then only when there is evidence no trains are approaching the crossing.

You should stop if a train is approaching and has sounded its audible signal or is plainly visible and in hazardous proximity to the crossing.

Do not stop your vehicle on a railroad track, regardless of whether a train appears to be coming. If traffic is backed up because of a traffic signal, stop sign or for any other reason, make sure you stop your vehicle in a location where it will be entirely clear of any railroad tracks.

Refer to Chapter 3 for more information about how to safely cross a highway-railroad intersection.

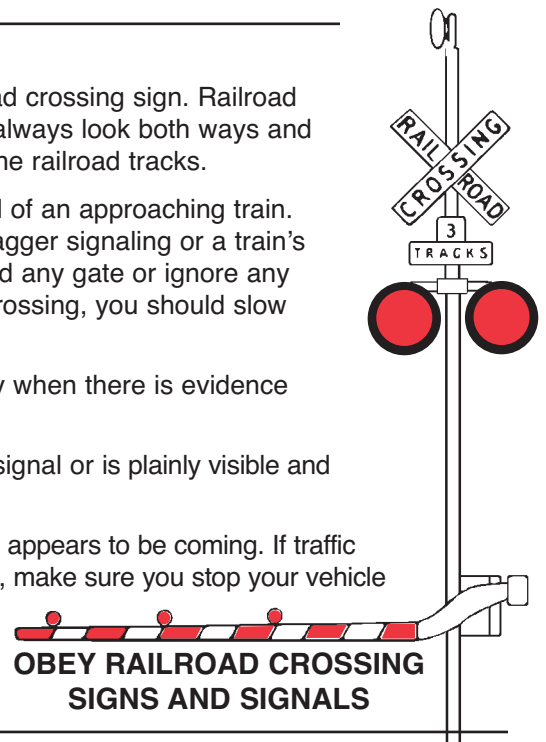

SIGNS

Signs are divided into three (3) basic categories: Regulatory, Warning and Guide signs. Most signs within each category have a special shape and color.

REGULATORY SIGNS

Regulatory signs tell you what you must do, or must not do, according to the law. The regulations posted on these signs advise you about speed limits, the direction of traffic, turning restrictions, parking restrictions, etc. If you do not obey the messages on regulatory signs, you could be fined and receive points on your driving record because you are breaking the law. You also risk your safety and the safety of others by disobeying the messages on regulatory signs – for example, failing to stop at a stop sign, passing another car where it is not safe to pass, driving faster than the posted speed limit or driving the wrong way on a one-way street.

Usually, regulatory signs are black and white vertical rectangles or squares, like **SPEED LIMIT** signs. Some regulatory signs are black, white and red, like the **NO LEFT TURN** sign with a circle and slash. Other regulatory signs are red and white, like **STOP**, **YIELD**, **DO NOT ENTER** and **WRONG WAY** signs.



The **STOP** sign is the only octagon-shaped (8-sided) sign you see on the highway. At an intersection with a **STOP** sign, you must stop completely, check for pedestrians and cross traffic to clear the intersection before you go again. Slowing down without coming to a full stop is illegal.

When you see a crosswalk or a stop line (white top bar), stop before the front of your vehicle reaches the first painted line. If you cannot see traffic, yield to any pedestrians and then carefully pull forward past the line until you can see clearly. Check for traffic and pedestrians and then go ahead when the intersection is clear.



This sign is also used in conjunction with stop signs. This sign allows motorists to make the right turn without stopping.



A **FOUR-WAY STOP** sign means there are four stop signs at this intersection. Traffic from all four directions must stop. The first vehicle to reach the intersection should move forward first. If two vehicles reach the intersection at the same time, the driver on the left yields to the driver on the right. If facing one another both can proceed with caution, watching for possible turns.



YIELD signs are triangular (3-sided) in shape. When you see this sign, you must slow down and check for traffic and give the right-of-way to pedestrians and approaching cross traffic. You stop only when it is necessary. Proceed when you can do so safely without interfering with normal traffic flow. Remember, you must have a sufficient gap in traffic before you can continue on at either **STOP** or **YIELD** sign locations.



This sign is used in conjunction with a yield sign at a one-lane bridge or underpass location to alert motorists the one-lane roadway requires them to yield the right-of-way to opposing traffic.



RAILROAD CROSSBUCK SIGN This sign is placed at a railroad crossing where the tracks cross the roadway. You should treat the crossbuck sign as a **YIELD** sign; slow down and prepare to stop, if you see or hear a train approaching. Refer to Chapter 3 for more information about railroad crossing safety.



The **DO NOT ENTER** and **WRONG WAY** signs work as a team. The **DO NOT ENTER** sign is put at the beginning of one-way streets and ramps. When you see this sign, do not drive onto that street or ramp in the direction you are heading.

WRONG WAY signs are placed farther down the one-way street or ramp. They are placed there to catch your attention, if you accidentally turn onto the street or ramp.



The **ONE WAY** sign means traffic is allowed to move only in the direction the sign is pointing. If you turn onto a one-way street traveling in the opposite direction, you are likely to get into a head-on collision.



DIVIDED HIGHWAY

This sign means the road you are on intersects with a divided highway. The divided highway is really two (2), one-way roadways that are separated by a median or a guide rail. At the first roadway, you can only turn right, and at the second roadway, you can only turn left.



NO TRUCKS



NO BICYCLES



NO PEDESTRIAN CROSSING

NO TRUCKS, NO BICYCLES and NO PEDESTRIAN CROSSING

Operators of trucks, bicycles and pedestrians may not use roadways where these signs are posted.

The following signs are located where certain actions are prohibited at any or all times:



NO U-TURN

This sign prohibits U-turns. Do not make a complete turn to go in the opposite direction.



NO RIGHT TURN

This sign indicates right turns are prohibited. Do not make a right turn at this intersection.



NO LEFT TURN

This sign indicates left turns are prohibited. Do not make a left turn at this intersection.



NO PARKING

You may not park a vehicle at locations where this sign is posted.



DO NOT PASS

This sign may be placed in areas where you may not pass any vehicles going in the same direction. It is often accompanied by the yellow pennant-shaped sign that says **NO PASSING ZONE** (Refer to "Warning Signs").

The following **LANE USE CONTROL SIGNS (Directional)** are placed at or near intersections above the traffic lane they control to show what maneuver(s) are permitted from that lane.





This sign indicates that at the intersection ahead traffic in the left lane must turn left and traffic in the adjoining lane may turn left or continue straight.



CENTER LANE LEFT TURN ONLY

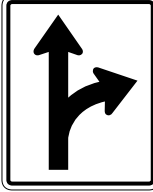

This sign indicates where a lane is reserved for the exclusive use of left-turning vehicles in either direction and is not to be used for through traffic or passing.





LANE USE CONTROL SIGNS *(continued)*

 <p>TURN TO LEFT OR RIGHT</p> <p>If you are in a lane controlled by signs like these, you may travel in either direction the arrows point.</p>	 <p>STRAIGHT OR TURN RIGHT</p>	 <p>TURN RIGHT ONLY</p>	 <p>TURN LEFT ONLY</p>
<p>If you are in a lane controlled by signs like these, you may travel in either direction the arrows point.</p>		<p>If you are in a lane controlled by a sign with a turn arrow and the word "ONLY," when you reach the intersection, you must make the turn. You may travel only in the direction the arrow points, even if you are in the turn-only lane in error.</p>	

	 <p>KEEP RIGHT These signs direct drivers to keep to the right of the traffic island or divider.</p>	 <p>RIGHT TURN SIGNAL This sign is posted close to a traffic signal to indicate that the signal controls right turn movements.</p>
---	--	---

	<p>A SPEED LIMIT sign indicates the maximum legal speed under ideal conditions for the stretch of highway where it is posted. Your safety may depend upon driving slower than the posted speed under poor conditions.</p>	<p>TEEN CRASH FACT</p> <p>"Driving too fast for conditions" is the No. 1 reason 16 and 17-year-old drivers are involved in crashes.</p>
--	--	--

	 <p>ON RED</p>	 <p>ON RED</p>	<p>You may not turn during the red light cycle at an intersection where one of these signs is posted. You must wait for the signal to turn green.</p>
---	--	--	---

		<p>LEFT TURN YIELD ON FLASHING YELLOW ARROW This sign indicates a left turn is permitted when the yellow arrow is flashing, but you must yield to oncoming traffic. This sign is commonly placed at intersections, near the left turn traffic signal, to inform drivers left turns are not protected when the flashing yellow arrow is operating.</p>
		<p>LEFT TURN YIELD ON GREEN This sign indicates a left turn is permitted, but you must yield to oncoming traffic. It is commonly placed at intersections, near the left-turn traffic signal, to remind drivers left turns are not protected when the circular green signal comes on.</p>
		<p>OPPOSING TRAFFIC HAS EXTENDED GREEN This sign is posted where opposing traffic may continue to move after your signal has turned red.</p>

	<p>RESERVED PARKING Although this sign is not black and white, it is a regulatory sign. It marks areas where parking is reserved for disabled persons or severely disabled veterans. Vehicles parked in these spaces must display authorized registration plates or parking placards. Unauthorized vehicles parked in these spaces are subject to a fine and towing costs.</p>
---	---

WARNING SIGNS

Warning signs tell you about conditions on or near the road ahead. They warn you about possible hazards or changes in roadway conditions. They are posted before the condition, so you have time to see what is ahead, decide how you should respond and slow down or change your travel path, if necessary. Warning signs are usually diamond shaped with black symbols or words on a yellow background.



NO PASSING ZONE

This is the only pennant-shaped warning sign. This sign marks the beginning of a no passing zone and is placed on the left side of the road facing the driver.

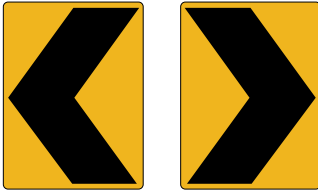

CHEVRON SIGNS

There is a sharp change in the direction of the road, such as a curve to the left or right. The road bends in the direction the chevron points. When used in a curve, there will be an advanced curve warning sign, and there may be several chevron signs placed throughout the curve.



LEFT CURVE

The road curves ahead to the left. You need to slow down, stay in the center of your lane and prepare to navigate through the left-bending curve.



RIGHT CURVE

The road curves ahead to the right. You need to slow down and position your vehicle slightly to the right of the center of your lane, as you drive through the right-bending curve.



SHARP LEFT TURN

The road ahead turns sharply to the left. You need to slow down substantially, stay in the center of your lane and prepare to navigate through the sharp left turn. Some sharp turn signs have an advisory speed located on the sign or posted below it.



SHARP RIGHT TURN

The road ahead turns sharply to the right. You need to slow down substantially, position your vehicle slightly to the right of the center of your lane and prepare to navigate through the sharp right turn. Some sharp turn signs have an advisory speed located on the sign or posted below it.

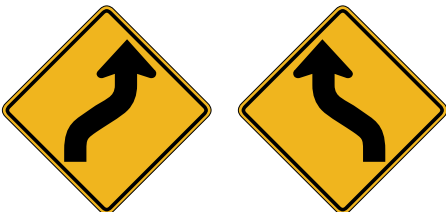

SET OF CURVES

The road ahead curves first in one direction and then back in the other direction (a set of two (2) curves). Slow down and prepare to navigate through the set of curves.

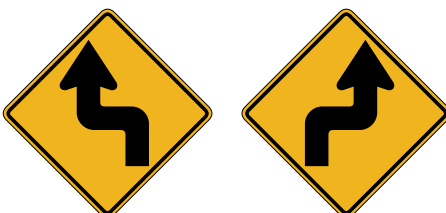

RIGHT AND LEFT SHARP TURNS

The road ahead turns sharply first in one direction and then back in the other direction. Slow down substantially and prepare to navigate through the set of turns.

**WINDING ROAD (SERIES OF CURVES)**

This sign indicates there are three (3) or more curves in a row on the road ahead.

**ONE DIRECTION LARGE ARROW**

The road ahead changes direction at an extreme angle. Before you reach such an extreme curve, slow down as much as you would to make a turn at an intersection.

**ROAD ENTERING CURVE**

The main road curves to the left with a side road entering from the right. Approach the intersection with extra caution. A driver preparing to enter the main road may not be able to see you approaching from around the curve and may pull out in front of you, leaving you little room to avoid a crash, if you are traveling too fast.

**TRUCK ROLLOVER**

This sign identifies curves where trucks traveling at excessive speeds have a potential to rollover.

**ADVISORY SPEED SIGNS**

This sign may be used with any diamond-shaped warning sign. The highest speed you should travel around a sharp left curve ahead is 25 mph.

**MERGING TRAFFIC**

This sign is placed on a major roadway to tell you traffic may be merging into your lane from another roadway or a ramp. In this example, the traffic will be entering your lane from the right. Entering traffic must yield to traffic already on the major roadway.

**ADDED LANE**

This sign is placed in advance of a point where two roadways meet. It means merging is not necessary because the entering traffic uses a new lane that has been added to the roadway.

**WEAVE AREA**

This sign is used to warn that you will be merging with another roadway as some traffic is exiting and crossing your path.



DIVIDED HIGHWAY BEGINS
 The highway ahead becomes a divided highway with two one-way roadways and a median or divider separating traffic moving in opposite directions. Keep to the right of the divider or median.



DIVIDED HIGHWAY ENDS
 The divided highway on which you are traveling ends ahead. You will then be on a roadway with two-way traffic. Keep to the right of the centerline and watch for oncoming traffic.



TWO-WAY TRAFFIC AHEAD
 The one-way street or roadway ends ahead. You will then be traveling on a road with two (2) lanes of traffic moving in opposite directions. Stay in your lane to the right of the centerline. This sign may also be placed at intervals along the two-way roadway.



LANE ENDS
 These signs tell you one (1) lane on a multi-lane roadway will end ahead. In these examples, the traffic in the right lane must merge left.

INTERSECTION SIGNS

The signs below show types of intersections. By showing you in advance how the roads join each other, the signs let you know when the road you are traveling on does not continue straight through the intersection. The signs also warn you about possible problems with the movements of other vehicles. Approach all of these intersection types with extra caution by searching ahead and preparing to slow down, if necessary.



CROSS ROAD



SIDE ROAD



"T" INTERSECTION



"Y" INTERSECTION



CIRCULAR INTERSECTION



TWO DIRECTION LARGE ARROW
 This sign is placed at the far side of a T-intersection to tell you that you can only go left or right. The road you are on does not continue straight through at the intersection.



NARROW BRIDGE OR UNDERPASS AHEAD
 Each lane on the bridge or underpass becomes narrower, and there generally is no shoulder. You need to slow down and make sure you stay in your lane. If a driver approaching from the opposite direction has a wide vehicle or is taking up part of your lane, wait until they clear the area.



SLIPPERY WHEN WET
 Especially slippery conditions exist when wet. In wet weather, reduce your speed and increase your following distance. Do not accelerate or brake quickly. Make turns at a very slow speed.



DEER CROSSING

This sign is posted in areas where deer frequently cross and crashes with deer have occurred.



LOW CLEARANCE

This sign may be placed on an underpass, or at the entrance to a tunnel or parking garage. Do not enter if your vehicle is taller than the height listed on the sign.



SHOULDER SIGNS

These signs are placed in advance of locations where the shoulder is lower than the road or the shoulder is soft (not paved). The **LOW SHOULDER** sign is used where the shoulder is as much as three (3) inches below the level of the road. The **SHOULDER DROP OFF** sign is used for even more severe drop-off situations.

If you stray off of the roadway and one (1) wheel drops off onto a low shoulder or a soft shoulder, do not slam on the brakes or steer sharply to try to get back onto the roadway—you can easily lose control of your vehicle! Refer to Chapter 3 for information about how to safely recover from drifting off of the pavement.



HILL/DOWNGRADE

There is a steep hill ahead. Slow down and be ready to shift to a lower gear to control your speed and to save wear and tear on your brakes.



TRAFFIC SIGNAL AHEAD

A traffic signal is present at the intersection ahead. You may not be able to see it because of a curve or hill. If the light is red (or if the light has just turned green), a line of vehicles may be stopped ahead. When you see this sign, slow down and prepare to stop, if necessary.



STOP SIGN AHEAD

A **STOP** sign is present at the intersection ahead. You may not be able to see it because of a curve, hill or something else blocking your view. There also may be a line of vehicles stopped ahead at the **STOP** sign you cannot see. When you see this sign, slow down in preparation to stop.



BICYCLE CROSSING AHEAD

Bicyclists may be crossing your path ahead. Be prepared to slow down, if necessary. This sign may have either a yellow background (as shown) or a fluorescent yellow-green background.



RAILROAD CROSSING AHEAD

You are approaching a railroad crossing. When you see this sign, begin looking and listening for a train. This sign is placed far enough in advance to allow you to stop before you reach the tracks, if necessary. Refer to Chapter 3 for more information about railroad crossing safety.

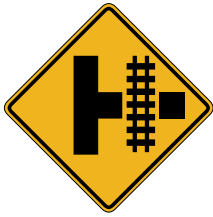

ADVANCED INTERSECTION/RAILROAD CROSSING SIGN

The intersecting road has a railroad crossing within a very short distance from the intersection. If you are planning to turn onto the intersecting road and if a train is approaching, be prepared to stop.



BICYCLE/MOTOR VEHICLE SHARE THE ROAD

Used at roadway pinch points (no shoulder, narrow lanes, etc.) to warn you, as a motorist, to provide adequate space for bicyclists to share the roadway.



PEDESTRIAN CROSSING

Used at a marked crosswalk or in advance of locations where pedestrians may be crossing your path. Be prepared to slow down or stop, if necessary. This sign may have either a yellow background (as shown) or a fluorescent yellow-green background.



SCHOOL

This is the only pentagon-shaped sign used on the roadway. It means you are approaching a school zone. If the sign is accompanied by a downward-pointing arrow, it means you are at the school zone crosswalk. You should slow down, watch for children crossing the road and stop, if necessary. This sign may have either a yellow background (as shown) or a fluorescent yellow-green background.



HORSE-DRAWN VEHICLE

This sign is posted in areas where slow moving, horse-drawn vehicles cross or share the roadway with motorized vehicles.

OBJECTS ADJACENT TO THE ROADWAY

Objects close to the edge of the road sometimes need a marker to warn drivers of the potential danger. These include underpass supports, ends of bridges, guiderails and other structures. In some cases, there may not be a physical object involved, but rather a roadside condition such as a drop-off or an abrupt change in the roadway alignment. Such roadside objects and conditions are indicated by the following markers, where the stripes are angled down in the direction you need to move to avoid the hazard:

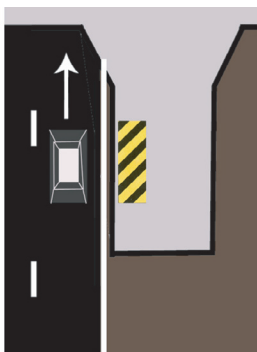

Right Hazard
Keep to the Left

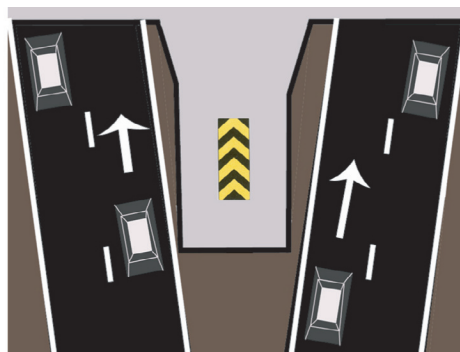

Center Hazard
Keep to the Left or Right

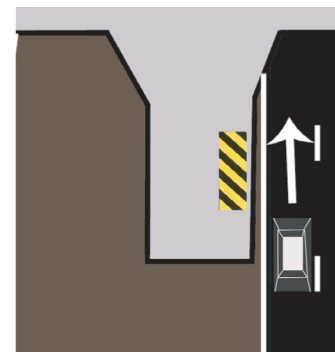

Left Hazard
Keep to the Right

WORK ZONE SIGNS (WORK AREA AND CONSTRUCTION ZONE SIGNS)

Work Zone Signs are normally diamond shaped, like warning signs, but they are orange with black lettering instead of yellow with black lettering. These signs identify maintenance, construction or utility areas where workers or equipment may be on or near the roadway. Stay alert and slow down when you see these signs.



Turn on your headlights when traveling through a work zone, no matter what time of day. This is the law for **all** posted work zones, not just for active ones. Using your headlights makes your vehicle more visible to other traffic as well as to highway workers. If you are pulled over by police for a traffic violation in a work zone and your vehicle's headlights are not turned on, you will be fined an additional \$25.

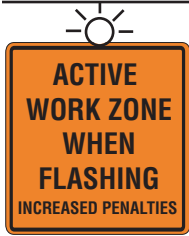

These **WORK ZONE** signs are placed at the beginning and end of an active work zone. An active work zone is the portion of a work zone where construction, maintenance or utility workers are on the roadway, or on the shoulder of the highway next to an open travel lane.



ROAD WORK AHEAD
This sign informs you there is road work ahead and also cautions you to slow down.



LANE CLOSED AHEAD
This sign tells you a particular lane will be closed at a specified distance ahead.



WORKERS AHEAD
Workers may be on or are very close to the roadway, so take special care when traveling through the area.



ROAD CLOSED FLOODING
This sign informs you that the road ahead is closed due to flooding. You must use an alternate route. Refer to Chapter 3 about what to do if you encounter a flooded roadway.

DID YOU KNOW?
Highway workers have forms to report motorists who speed or drive unsafely in work zones to the police, who may then issue a ticket, resulting in fines and points.



FLAGGER AHEAD (ROAD CONSTRUCTION AHEAD)
The sign to the left shows a flagger is controlling traffic ahead. As shown to the right, flaggers use **STOP** and **SLOW** paddles or a red flag to signal you to stop or slow down. Pay special attention to flaggers when approaching and traveling through a work zone.



TRAFFIC MUST STOP AND WAIT



TRAFFIC MUST MOVE SLOWLY

ELECTRIC ARROW PANELS

Large electronic flashing arrow panels (move/merge right or left) placed in the roadway or mounted on vehicles advise approaching motorists of lane closures. Begin your merge well in advance of the sign. An arrow panel displaying either of the messages shown in the figure to the far right (caution) indicates there is a work area ahead next to the travel lane. Drive with extra caution.

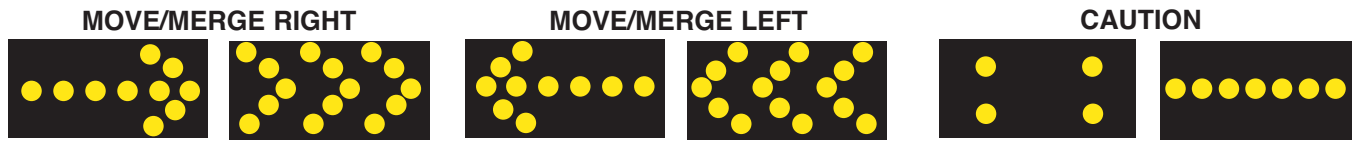

CHANNELING DEVICES

Barrels, tubes, cones and vertical panels are all devices used in work zones to guide you through changing traffic patterns and keep you away from hazards associated with road work.

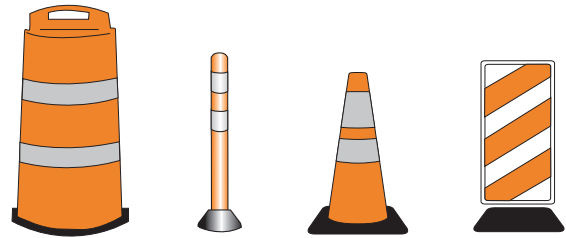

GUIDE SIGNS

Guide signs provide information about intersecting roads, help direct you to cities and towns, and show points of interest along the highway. Guide signs also help you find hospitals, service stations, restaurants and motels. Usually these signs are horizontal rectangles.

HIGHWAY/EXPRESSWAY GUIDE SIGNS

The following three signs are examples of highway and expressway guide signs. They are green with white letters. Most highway and expressway signs are posted the same way. For example, there is usually one advance sign which is followed by another advance sign. The third sign then is posted at the exit. Several signs are necessary because the high speed and heavy traffic on highways can cause drivers to miss seeing a single sign. Also, motorists may need to make one or more lane changes to exit.



EXIT NUMBERS

Exit numbers correspond with the mile markers. This change allows motorists to quickly calculate distances between exits, e.g., the distance between Exit 95 and Exit 20 is 75 miles.

If a yellow panel with the message **EXIT ONLY** is on a highway sign, the lane below the sign will not continue through the interchange; instead, the lane will go off of the road to form a ramp. If you are in a lane posted with an **EXIT ONLY**, you may change lanes, or you must exit the highway if you stay in this lane.



HERE ARE SOME TIPS TO LET YOU KNOW WHICH SIDE OF THE HIGHWAY YOU WILL EXIT:

Exit 13 for Route 22 will be on the left side of the highway.



Exit 7 for Route 22 will be on the right side of the highway.

- The small green **EXIT** number sign on top of the green rectangular sign will be on the **left** side of the sign, if the exit is on the **left** side of the highway.
- The small green **EXIT** number sign on top of the green rectangular sign will be on the **right** side of the sign, if the exit is on the **right** side of the highway.
- If the sign has white arrows, the arrow will point in the direction of the exit.

INTERSTATE NUMBERING SYSTEM

The red, white and blue shield sign indicates a highway is an interstate. These interstates are specially numbered to help motorists find their way through unfamiliar areas. A code is used to show if the route travels mainly east and west or north and south, and to show if the route is in the eastern, middle or western United States.

Decoding the Interstate Numbering System. The numbers on the interstate shield can be a great navigational aid when you understand how they are developed. They generally follow this pattern:

- One or two-digit, **even**-numbered interstates are generally east-west routes. Nationally, the numbers increase from I-10 in the south to I-94 in the north. In Pennsylvania, I-76 is in the southern part of the state, and I-84 and I-80 are in the northern part.
- One or two-digit, **odd**-numbered interstates are generally north-south routes. Numbers increase from the west coast I-5 to the east coast I-95. In Pennsylvania, I-79 is in the western part of the state, and I-95 is in the eastern part.
- Three-digit numbered interstate highways connect to other major highways. If the first of the three (3) digits is an **even** number, the highway usually connects to interstate highways at both ends, such as I-276 in Philadelphia. Many times such routes are known as “loops” or “beltways.”
- When the first of the three (3) digits is an **odd** number, the highway is usually a “spur” route connecting with another interstate at only one (1) end, sometimes going into a city center such as I-180 in Williamsport.

MILE MARKERS

Mile markers are used on some highways to indicate the number of miles from the point where the traffic route entered the state or from its beginning, if it does not extend to the state borders. The numbers start at zero in the western part of the state for east-west roadways and in the southern part of the state for north-south roadways. The numbers increase as you travel east or north and decrease as you travel west or south. For example, when you enter Pennsylvania from the west on Interstate I-80, the mile markers begin at Mile 1 and increase as you travel east. Knowing how to read mile markers can help you to know exactly where you are and give an approximate location, if you have to call for roadside assistance.

ROUTE MARKERS

The following signs indicate the route on which you are traveling.



The route marker shows you the road is **U.S. Traffic Route 22**.



The keystone marker shows you the road is **Pennsylvania Traffic Route 39**.



The **junction plate** on this route marker shows you are approaching the intersection of U.S. Traffic Route 22.



The **direction plate** on this route marker shows you are traveling west on U.S. Traffic Route 22.



The **supplemental arrow** on this route marker assembly means you are approaching a right turn to continue on U.S. Traffic Route 22 West.



The **route marker sign and "TO" trailblazer sign and the supplemental arrow** means if you want to gain access to U.S. Traffic Route 22, you must continue ahead.

SERVICE SIGNS

The following signs are examples of service signs. The signs are square or rectangular, are blue with white letters or symbols, and show the location of various services located at the next exit.



HOSPITAL



TELEPHONE



FOOD



GAS



DIESEL



LODGING

TOURIST-ORIENTED DIRECTIONAL SIGNS

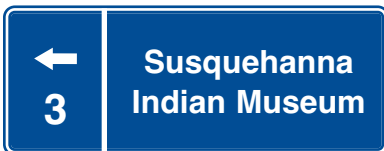

These signs are square or rectangular and may be blue or brown with white lettering. The signs direct motorists to tourist attractions such as museums, historical landmarks, or state or national parks.

PAVEMENT MARKINGS

Most roads have permanent markings to show the center of the road, travel lanes or road edges. The markings that show the center of the road are solid or broken lines. These pavement markings also indicate special lane use. Yellow lines divide traffic traveling in opposite directions. Yellow lines are used to mark the center of two-lane roads, and to mark the left edge of divided highways, one-way streets and ramps. Solid white lines divide lanes of traffic traveling in the same direction. Solid white lines are also used to mark the right edge of the road.

As a general rule, broken traffic lines can be crossed and solid lines cannot, except when making a turn. Some examples of different pavement markings and their meanings follow:

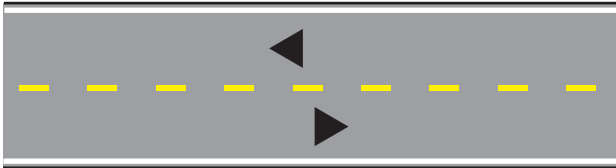

A single, broken yellow centerline shows the center of a two-way, two-lane road. Passing is permitted on either side, if safe conditions exist. When passing, you must use the lane belonging to oncoming traffic.

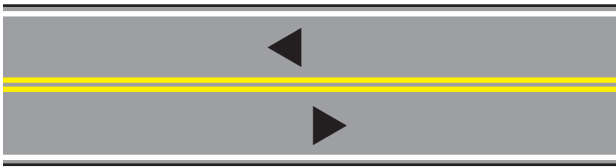

A double, solid yellow centerline shows the center of a two-way road. Even if it is not marked with a **NO PASSING** sign, passing by traffic traveling in either direction is not allowed on roads marked in this manner.

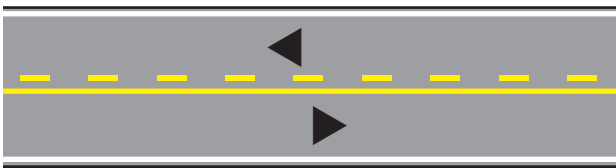

The combination of a solid yellow and a broken yellow centerline also shows the center of a two-way roadway. You may pass if the broken line is on your side of the road and safe conditions exist, but you may not pass when a solid yellow line is on your side of the road.

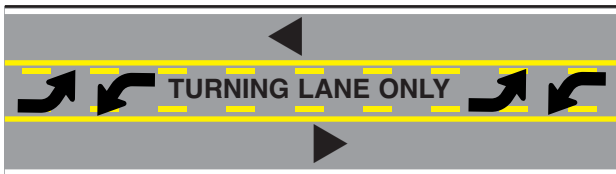

Marking patterns like these may be found on many three-lane or five-lane highways. The outside, solid yellow centerline means you cannot use the center lane for passing. The inside, broken yellow and solid yellow centerlines show vehicles traveling in either direction may use the center lane only to make left turns. Refer to Chapter 3 for more information about using center turn lanes safely.

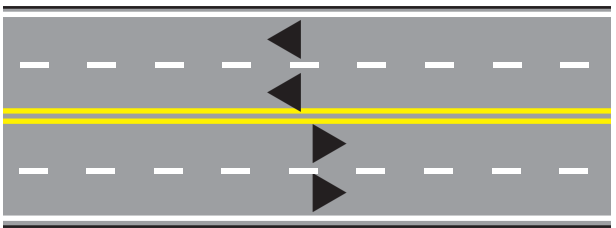

Multi-lane highways without medians (center dividers) are often marked as shown. Broken white lines show which lanes can be used by vehicles traveling the same way. You may cross the broken white lines to pass, (be sure the passing lane is clear) but you may not cross the double yellow centerlines to pass. Traffic is traveling in the opposite direction in the lane to the left of the yellow centerline.

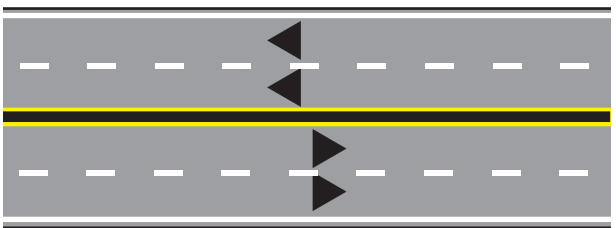

This pattern is used on most limited access highways with medians (center dividers). The right edge of the road is marked with a solid white line. The left edge of each side is marked by a solid yellow line. The traffic lanes for each side are marked by broken white lines, which may be crossed.

Pavement markings also include words painted on the pavement and arrows that supplement messages posted on regulatory and warning signs. Examples include the words **STOP AHEAD** before an intersection with a **STOP** sign, **YIELD** or white triangles painted across the lane to indicate you must yield to approaching traffic, **SCHOOL** before a school zone, **R X R** before a railroad crossing, **BIKE LANE** for a lane reserved for bicyclists, **ONLY** with a left or right arrow to indicate the lane is reserved for turns only and large white arrows to indicate the direction of travel on one-way streets and highway off-ramps.

CHAPTER 2 REVIEW QUESTIONS

1. WHEN YOU SEE THIS SIGN, YOU MUST:

- A. Stop completely, check for pedestrians, and cross traffic
- B. Slow down without coming to a complete stop
- C. Stop completely and wait for a green light
- D. Slow down and check for traffic

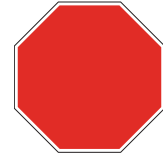

2. THIS IS THE SHAPE AND COLOR OF A _____ SIGN.

- A. Stop
- B. Wrong Way
- C. Yield
- D. Do not enter



3. THIS SIGN MEANS:

- A. Stop
- B. No U-Turn
- C. Yield
- D. Do not enter



4. THIS SIGN MEANS:

- A. No U-Turn
- B. No Turning
- C. No left turn
- D. No right turn



5. THIS SIGN MEANS:

- A. No U-Turn
- B. No left turn
- C. No right turn
- D. No turning



6. THIS SIGN MEANS:

- A. You must turn left or right
- B. You are approaching a T-intersection
- C. The road that you are on intersects with a divided highway
- D. Designates an overpass above a divided highway

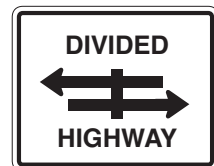

7. YOU NEED TO USE EXTRA CAUTION WHEN DRIVING NEAR A PEDESTRIAN USING A WHITE CANE BECAUSE:

- A. They are deaf
- B. They have a mental disability
- C. They are blind
- D. They have a walking problem

8. WHEN DRIVING NEAR A BLIND PEDESTRIAN WHO IS CARRYING A WHITE CANE OR USING A GUIDE DOG, YOU SHOULD:

- A. Slow down and be prepared to stop
- B. Take the right-of-way
- C. Proceed normally
- D. Drive away quickly

9. IF THERE ARE NO SIGNALS AT A RAILROAD CROSSING, YOU SHOULD:

- A. Slow down and prepare to stop if you see or hear a train approaching
- B. Proceed as quickly as possible over the tracks
- C. Proceed through the crossing at a normal rate
- D. Proceed slowly over the tracks

**10. YOU MAY DRIVE AROUND THE GATES AT A RAILROAD CROSSING:**

- A. When the train has passed
- B. Never
- C. When the lights have stopped flashing
- D. When other drivers drive around the gates

11. IF YOU SEE THIS SIGN ABOVE YOUR LANE, YOU:

- A. May not exit the freeway in this lane
- B. May continue through the interchange or exit the freeway in this lane
- C. May stay in this lane and continue through the interchange
- D. Must exit the freeway if you stay in this lane

**12. HIGHWAY AND EXPRESSWAY GUIDE SIGNS ARE:**

- A. Orange with black letters
- B. Green with white letters
- C. Yellow with black letters
- D. Red with white letters

13. THIS SIGN IS USED TO WARN DRIVERS ABOUT:

- A. Upcoming intersections
- B. Road construction
- C. Road curves ahead
- D. Changes in traffic lanes

**14. THIS SIGN TELLS YOU THAT:**

- A. No turns are allowed on this road
- B. The road narrows ahead
- C. There are a series of curves ahead
- D. The road may be slippery when wet

**15. THIS SIGN MEANS:**

- A. Left curve ahead
- B. Series of curves
- C. S curved ahead
- D. Slippery when wet

**16. THIS SIGN INDICATES THAT:**

- A. There is a steep hill ahead
- B. No trucks are allowed on the hill
- C. A logging road is ahead
- D. There are trucks on the hill

**17. A YELLOW AND BLACK DIAMOND-SHAPED SIGN:**

- A. Warns you about conditions on or near the road
- B. Helps direct you to cities and towns ahead
- C. Tells you about traffic laws and regulations
- D. Tells you about road construction ahead



18. THE SIGN WITH THIS SHAPE AND COLOR IS A _____ SIGN.

- A. No passing zone
- B. Wrong way
- C. Railroad crossing
- D. Stop

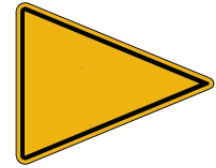

19. WHICH OF THESE SIGNS IS USED TO SHOW THE END OF A DIVIDED HIGHWAY?

- A. 2
- B. 4
- C. 3
- D. 1



20. THIS SIGN IS USED TO WARN DRIVERS ABOUT:

- A. Lane ends, merge left
- B. Road curves ahead
- C. Upcoming intersections
- D. Road construction



21. THIS SIGN SHOWS ONE TYPE OF:

- A. Intersection
- B. Road curve
- C. Right turn
- D. Lane change



22. THIS SIGN SHOWS ONE TYPE OF:

- A. Right turn
- B. Intersection
- C. Lane change
- D. Road curve



23. WHAT SHOULD YOU BE MOST CONCERNED ABOUT WHEN YOU SEE THIS SIGN?

- A. Driving with your headlights out of alignment because one side of your car is higher than the other
- B. Damaging a tire, if you drift onto the shoulder
- C. Hydroplaning, if the shoulder has water on it
- D. Losing control of your vehicle, if you drift onto the shoulder, because of a drop off



24. WHAT IS THE MEANING OF THIS SIGN?

- A. The traffic signal ahead is red
- B. The traffic signal ahead is broken
- C. The traffic signal ahead is green
- D. There is a traffic signal ahead



25. THIS SIGN MEANS:

- A. Divided highway ends
- B. One-way street begins
- C. One-way street ends
- D. Divided highway begins



26. FROM TOP TO BOTTOM, THE FOLLOWING IS THE PROPER ORDER FOR TRAFFIC LIGHTS:

- A. Red, yellow, green
- B. Red, green, yellow
- C. Green, red, yellow
- D. Green, yellow, red



27. IF A GREEN ARROW TURNS INTO A GREEN LIGHT, YOU:

- A. May still turn but you must yield to oncoming traffic
 - B. May no longer turn and must proceed straight
 - C. Still have the right of way to turn
 - D. No longer have to turn the way the arrow indicates
-

28. A STEADY YELLOW LIGHT AT AN INTERSECTION MEANS:

- A. Go
 - B. Yield to other cars
 - C. Slow down and prepare to stop
 - D. Stop
-

29. A FLASHING YELLOW ARROW MEANS THAT YOU:

- A. Should stop and proceed with the turn when a green arrow appears
 - B. Should slow down and prepare to stop
 - C. May turn, but must first yield to oncoming traffic and pedestrians
 - D. Have the right of way to turn
-

30. A FLASHING YELLOW LIGHT MEANS THAT YOU SHOULD:

- A. Slow down and proceed with care
 - B. Continue through if the way is clear
 - C. Stop and proceed when a green light appears
 - D. Stop and proceed when the way is clear
-

31. YOU MUST STOP WHEN YOU SEE A:

- A. Flashing red light
 - B. Steady yellow light
 - C. Yellow arrow
 - D. Flashing yellow light
-

32. A STEADY GREEN LIGHT AT AN INTERSECTION MEANS THAT YOU:

- A. Must slow down and prepare to stop
 - B. Must stop and check for oncoming traffic before proceeding
 - C. May drive through the intersection if the road is clear
 - D. May not turn right
-

33. A STEADY YELLOW LIGHT MEANS THAT A _____ LIGHT WILL SOON APPEAR.

- A. Flashing yellow
 - B. Steady green
 - C. Steady red
 - D. Flashing red
-

34. YOU MAY CONTINUE CAREFULLY THROUGH A YELLOW LIGHT IF:

- A. There is an emergency vehicle crossing your lane
 - B. There are no pedestrians crossing
 - C. You are turning right
 - D. You are within the intersection
-

35. YOU MAY TURN LEFT AT A RED LIGHT IF:

- A. There is no traffic coming in the opposite direction
 - B. You are turning from a two-way street onto a one-way street
 - C. You are turning from a one-way street onto another one-way street
 - D. The car in front of you turns left
-

36. IF A TRAFFIC LIGHT IS BROKEN OR NOT FUNCTIONING YOU SHOULD:

- A. Stop and wait for it to be repaired
- B. Stop and wait for a police officer to arrive
- C. Continue as if it were a four-way stop sign
- D. Continue as you normally would

37. YOU MAY TURN RIGHT ON RED IF YOU:

- A. Stop first and check for traffic and pedestrians
- B. Have a right turn red arrow
- C. Are in the left lane
- D. Slow down first

38. WHEN MAKING A RIGHT TURN ON A GREEN LIGHT, YOU MUST:

- A. Maintain normal driving speed
- B. Stop and look for oncoming traffic
- C. Yield to pedestrians
- D. Increase your normal driving speed

39. THE SPEED LIMIT IS _____ MILES PER HOUR WHEN THE YELLOW LIGHTS ARE FLASHING ON THE SCHOOL ZONE SPEED SIGN.

- A. 25
- B. 15
- C. 20
- D. 35

40. A FLASHING RED LIGHT AT A RAILROAD CROSSING MEANS:

- A. Stop, do not proceed until signals are completed
- B. Slow down and proceed if clear
- C. Proceed with caution
- D. You have the right-of-way

41. THIS GREEN ARROW ON A LANE USE CONTROL SIGNAL MEANS THAT:

- A. You may use this lane
- B. No traffic is allowed in this lane
- C. You have the right-of-way
- D. You must merge into this lane

**42. THIS SIGN MEANS:**

- A. Pedestrians ahead
- B. End of construction zone
- C. School crossing ahead
- D. Flagger ahead

**43. THIS SIGN MEANS THAT:**

- A. A community service group is picking up trash along the highway ahead
- B. Workers are on or very close to the road in the work zone ahead
- C. Children are at play ahead
- D. There is a pedestrian crosswalk ahead

**44. WHEN AN ARROW PANEL IN A WORK ZONE SHOWS EITHER OF THE FOLLOWING PATTERNS, IT MEANS:**

- A. The bulbs on the sign are burned out
- B. Drive with caution
- C. Changes lanes immediately
- D. Tune your radio to a station that gives traffic updates



45. THE CENTER LANE IN THE ILLUSTRATION IS USED FOR:

- A. Regular travel
- B. Left turns only
- C. Passing only
- D. Emergency vehicles only



46. YOU MAY PASS IF THE LINE DIVIDING TWO LANES IS A _____ LINE.

- A. Broken white
- B. Double solid yellow
- C. Solid yellow
- D. Solid white

47. LANES OF TRAFFIC MOVING IN THE SAME DIRECTION ARE DIVIDED BY ____ LINES.

- A. Yellow
- B. White
- C. Red
- D. Black

48. YOU MAY NOT PASS ANOTHER CAR ON EITHER SIDE OF A _____ CENTERLINE.

- A. Combination solid and broken yellow
- B. Single broken yellow
- C. Double solid yellow
- D. Single broken white

49. YOU MAY CROSS SOLID YELLOW LINES:

- A. To pass traffic moving in the same direction
- B. During daylight hours only
- C. At any time
- D. When making turns

50. THE ROAD EDGE ON THE RIGHT SIDE IS MARKED BY A _____ LINE.

- A. Broken white
- B. Solid yellow
- C. Solid white
- D. Broken yellow audio

51. LANES OF TRAFFIC MOVING IN THE OPPOSITE DIRECTION ARE DIVIDED BY ____ LINES.

- A. White
- B. Red
- C. Black
- D. Yellow

52. WHEN YOU SEE THIS BLACK AND YELLOW SIGN, IT MEANS:

- A. The road to the right is for one-way traffic only
- B. Detour to the right because of road construction
- C. Slow down because the road ahead changes direction at an extreme angle
- D. There is a cross road ahead on your right



53. WHEN YOU SEE THIS SIGN, IT MEANS:

- A. There is an object on the roadway
- B. Traffic is coming from the right
- C. The road is curving sharply to the left
- D. There is a merge point ahead



54. AT AN INTERSECTION CONTROLLED BY A STOP SIGN, IF YOU CAN'T GET A GOOD VIEW OF CROSS-STREET TRAFFIC WHEN YOU STOP BEHIND THE WHITE TOP BAR PAINTED ON THE PAVEMENT, YOU SHOULD:

- A. Wait 5 seconds, then proceed.
- B. Sound your horn before proceeding
- C. Put down your windows, listen for traffic, and then proceed
- D. Pull forward slowly, check for traffic and pedestrians, and proceed when clear

55. THE POSTED SPEED LIMITS SHOW:

- A. The minimum legal speed limit
- B. The exact speed at which you must travel to avoid a ticket
- C. The maximum safe speed under ideal road and weather conditions
- D. The maximum safe speed under all road conditions



56. A HIGHWAY WITH TWO-WAY TRAFFIC IS MARKED BY WHICH OF THESE SIGNS?

- A. 1
- B. 2
- C. 3
- D. 4



57. FROM THE CENTER LANE, WHAT MANEUVERS CAN YOU PERFORM?

- A. Make left turns
- B. Make U-turns
- C. Pass slower-moving traffic
- D. All of the above



58. WHICH OF THESE SIGNS MEANS THAT DRIVERS SHOULD KEEP TO THE RIGHT?

- A. 2
- B. 1
- C. 3
- D. 4



CHAPTER 2 ANSWER KEY

- | | | |
|-------|-------|-------|
| 1. A | 20. A | 39. B |
| 2. C | 21. A | 40. A |
| 3. D | 22. B | 41. A |
| 4. A | 23. D | 42. D |
| 5. C | 24. D | 43. B |
| 6. C | 25. D | 44. B |
| 7. C | 26. A | 45. B |
| 8. A | 27. A | 46. A |
| 9. A | 28. C | 47. B |
| 10. B | 29. C | 48. C |
| 11. D | 30. A | 49. D |
| 12. B | 31. A | 50. C |
| 13. C | 32. C | 51. D |
| 14. C | 33. C | 52. C |
| 15. D | 34. D | 53. C |
| 16. A | 35. C | 54. D |
| 17. A | 36. C | 55. C |
| 18. A | 37. A | 56. C |
| 19. A | 38. C | 57. A |
| | | 58. A |

CHAPTER 3: LEARNING TO DRIVE

This chapter provides information that will help you become a safe driver. It covers these topics:

- Choosing Safety First
- Driver Factors
- Everyday Driving Skills
- Special Circumstances and Emergencies

CHOOSING SAFETY FIRST

You have important choices to make – sometimes even before you start your vehicle – that will affect your safety when you are behind the wheel. Begin by making sure you and your vehicle are “fit to drive.”

VEHICLE CHECKS: PREPARING TO DRIVE

- Tire Safety** – Tires are an important part of driving safety. Be sure your tires have adequate tread and air pressure prior to driving your car. Prior to entering the vehicle, check tire pressure using the recommended psi (pounds per square inch) located in the vehicle owner's manual or the driver's side door jamb of the vehicle. Use a tire pressure gauge to check your psi. Check your tires “cold” - before you've driven or at least three hours after you've driven. If your psi is above the number listed on your door jamb, let air out until it matches. If below, add air (or have a tire professional help you) until it reaches the proper number.

You may also measure tread depth using the penny test. Once every month, or before you embark upon a long road trip, check your tires for wear and damage problems. One easy way to check for wear is by using the penny test.

- Take a penny and hold Abraham Lincoln's body between your thumb and forefinger.
- Select a point on your tire where the tread appears to be lowest and place Lincoln's head into one of the grooves.
- If any part of Lincoln's head is covered by the tread, you're driving with the safe amount of tread. If your tread gets below that, your car's ability to grip the road in adverse conditions is greatly reduced.

Keep the tools you will need to change your tire in your vehicle at all times, i.e. spare tire, lug wrench, jack, flashlight, flares and reflective triangles, wheel wedges, a flat tire repair kit and gloves to name a few. For more information on how to change a tire, please refer to page 63.

- Fluids** – Check all fluid levels, i.e. engine oil, windshield washer, and fuel and fill as needed as per vehicle owner's manual.
- Adjust the driver's seat** – You must be able to easily reach the pedals and other controls and have a clear view out the windshield. Your owner's manual provides information about how to adjust your vehicle's equipment.
- Fasten your seat belt** – Fasten both your lap and shoulder belts on every trip. Pay attention to the information about Pennsylvania's seat belt law, child restraint law and air bag safety information found in Chapter 5.

WEARING YOUR SEAT BELT
is the single most effective
thing you can do to reduce
the risk of death or injury!

DID YOU KNOW?

In 2017, 80.2% of people involved in crashes in Pennsylvania were wearing seat belts. Drivers, ages 16 to 24, had the highest number of unbuckled injuries and fatalities of any age group and the lowest seat belt use.

- Secure loose items in the passenger compartment** – In a crash, loose items in your vehicle become projectiles that continue to travel the same speed your vehicle was moving before the impact. Put heavier objects, such as backpacks, luggage and tools in your trunk, whenever possible, or secure them with the vehicle's seat belts. Never store items on the rear window deck.
- Adjust the rearview and side mirrors** – To remove blind spots around your vehicle, the rearview and side mirrors may have to be adjusted differently for each driver. The rearview mirror should be set so you can see the traffic directly behind your vehicle. The side mirror(s) should be set so when you lean left/right you can just barely see the side of your vehicle. Set the mirrors after you adjust your seat.

Note: It is against the law to have any object or material hanging from the rearview mirror while moving. You may not hang, place or attach anything to the rearview mirror that might block or impair vision through the front windshield. Tags, permits and placards may only be attached to the rearview mirror when the vehicle is parked.

- Windshield** – It is against the law to place anything on the front windshield that blocks a driver's view of the roadway.

8. **Adjust ventilation** – You should maintain a constant supply of fresh air in your vehicle. This helps you stay alert and guards against carbon monoxide (exhaust gas) poisoning when you drive. Refer to Chapter 6 for more information about carbon monoxide poisoning.
9. **Adjust head restraints** – A head restraint that properly cushions the back of your head can prevent or reduce the severity of neck injuries in a crash. Adjust your head restraint so the top of the head restraint is at least as high as the top of your ears. Check your owner's manual for instructions.
10. **Wear your prescription glasses/contact lenses** – If you normally wear corrective lenses, always wear them while driving. Do not wear sunglasses or tinted contact lenses at night.
11. **Lock your doors** – Locking your doors and wearing your seat belt will help to ensure you will not be thrown from your vehicle in a crash. Being thrown from a vehicle increases your chances of death by 75 percent. It will also reduce the likelihood of being carjacked or otherwise victimized when you stop at an intersection or pull into a parking lot.

DRIVER FACTORS

Your vehicle may be ready to go, but your safety depends just as much on the following driver factors.

INATTENTION

Inattention great enough to cause a crash can result from driving distractions or lack of sleep.

DID YOU KNOW?

Driver distraction and inattention to road and traffic conditions are responsible for 25 to 30 percent of police-reported traffic crashes. This adds up to approximately 1.2 million crashes every year.

DRIVING DISTRACTIONS

Anything that causes you to **1) take your attention away from driving, 2) take your eyes off of the road or 3) take your hands off of the wheel** is a distraction. You will not be able to react as quickly if you are:

- Eating, drinking and smoking. These all create safety problems because they often require you to take your hands off of the wheel and take your eyes off of the road. Drivers who eat or drink while driving have trouble controlling their vehicle, staying in their lane and have to brake more often.
- Adjusting audio devices such as: radio, cassette, CD, Ipod/Mp3 player. NOTE: headphones/ear pieces can only be used in one ear for communication purposes.
- Talking on a cell phone (whether it is hands-free or not). Please refer to Chapter 5 for more information about anti-texting laws.
- Interacting with other passengers. This can be just as much of a problem, particularly for teenage drivers. **If you are a teen driver with other teens as passengers, statistics show you are more likely to have a crash than if you are driving alone or are driving with adult passengers.**
- Searching for or moving an object in the vehicle.
- Reading, writing or texting.
- Personal grooming (combing hair, applying makeup).
- Rubbernecking when passing a crash scene or a work zone.
- Looking at people, objects or events happening off of the roadway.

DID YOU KNOW?

Research has found a normal, undistracted driver fails to notice an important road event such as another driver making a mistake, three (3) percent of the time. An adult dialing a cell phone misses the same event 13 percent of the time. A teenager dialing a cell phone misses it 53 percent of the time.

LACK OF SLEEP

When you are tired, you react slower, your judgment and your vision are impaired, and you have problems with

understanding and remembering things. Driving while fatigued has similar effects as driving under the influence of alcohol. Being awake for 18 hours impairs your driving about as much as a blood alcohol level of .05 percent. Being awake for 24 hours in a row impairs your driving as much as having a blood alcohol level of .10 percent. If you are tired enough, you may fall asleep and never even know it. Sleeping behind the wheel for even a few seconds is enough to kill you. Teens who sleep less than eight (8) hours a night are at increased risk for vehicle crashes. **The best thing to do if you begin to feel tired while driving is to stop driving.**

DID YOU KNOW?

- Every year across the U.S., falling asleep while driving causes at least 100,000 crashes.
- 1,500 people die and 40,000 are injured in these crashes.
- **Of the 100,000 vehicle crashes linked to drowsy driving each year, almost half involve drivers between 15 and 24 years of age.**

HEALTH FACTORS

Your driving safety can be affected by problems with vision, hearing or medical conditions.

- Have your vision checked every one (1) or two (2) years. Your peripheral (side) vision, your distance judgment and your ability to see in low light conditions can deteriorate due to disease and as a normal part of the aging process. You will not always know this and be able to take corrective action, unless your vision is examined regularly. If you need to wear glasses or contacts, make sure you use them every time you drive.
- Hearing can warn you of dangers you do not see, like another vehicle in your blind spot. Hearing is also important to let you know an emergency vehicle (police, fire, ambulance) is approaching or to detect a train at a railroad crossing.
- Various diseases and medical conditions, even little problems like a stiff neck or sore knee, can have a serious impact on your ability to control your vehicle effectively. The most dangerous health problems include seizure disorders that cause loss of consciousness, diabetes and heart conditions. In Pennsylvania, physicians must report to PennDOT individuals whom they have diagnosed as having a condition that could impair their ability to drive safely.

ALCOHOL AND DRIVING

- In Pennsylvania and across the nation, drinking drivers are responsible for thousands of traffic deaths and injuries. Approximately 40 percent of all traffic deaths involve drinking drivers.
- Recent Pennsylvania statistics show that 30 percent of drivers ages 16 to 20 who died in motor vehicle crashes had been drinking. This is despite the fact that here in Pennsylvania, as well as in every other state in the U.S., there are **zero tolerance laws**, meaning you may not drink if you are under age 21.
- If you are a driver under age 21 and your blood alcohol concentration (BAC) is .02 percent or more, you are considered to be driving under the influence (DUI).
- Even the smallest amount of alcohol will reduce your concentration, perception, judgment and memory, and your driving skills will suffer. **No one can drink and drive safely.**
- As alcohol builds up in your blood, your driving errors will increase. Your vision and judgment will be affected, your reactions will slow down, and you will lose your ability to control your vehicle safely and effectively. And, at the same time, alcohol robs your skills, making you feel dangerously confident. So, drinking drivers can be out of control and not even know it.
- Many people believe only heavy drinking is risky. This is not true. Even drivers whose blood alcohol level is .04 (half of the "legal limit" of .08 for an adult 21 years of age or older) are between two (2) and seven (7) times more

DID YOU KNOW?

In the U.S., one (1) person dies every half hour and one (1) person is injured every two (2) minutes, because someone was drinking and driving.

likely to be involved in a crash than drivers who have no alcohol in their blood. Even if your blood alcohol level is well below the legal limit, you will still endanger your life and the lives of others. **The only safe amount of alcohol you can drink, and then drive, is zero.**

- Alcohol affects individuals differently. Your blood alcohol level is affected by your age, weight, gender, physical condition, amount of food consumed, and any drugs or medication you have in your system. In addition, different drinks may contain different amounts of alcohol too. Make sure you know how much alcohol is in the drinks you consume. You should consider one (1) drink to be 1.5 oz. of 80 proof liquor, 12 oz. of regular beer, or 5 oz. of wine.
- To manage your drinking responsibly, do not drink more than one (1) drink per hour, if you are of legal drinking age. It takes a person of average weight at least one (1) hour to process the alcohol in every drink. More than one (1) drink per hour is very likely to push your blood alcohol level over the legal limit.
- The one (1) drink per hour rule does not work for everybody, though. Alcohol is more concentrated in smaller people, and because of the differences in the way our bodies process alcohol, a woman drinking an equal amount in the same period of time as a man of the same weight may have a higher blood alcohol level.
- Only time will “sober you up.” You cannot reduce your blood alcohol concentration level by drinking coffee or other caffeinated beverages, or by taking a cold shower.

DID YOU KNOW?

A female who weighs 110 pounds will have a BAC of .03 after drinking just 8 oz. of light beer – that’s less than one full bottle or can. A 140-pound male will have a BAC of .025 after a full 12 oz. bottle or can of light beer.

PLAY IT SAFE.

DO NOT DRIVE AFTER DRINKING ANY AMOUNT OF ALCOHOL, AND KEEP THE DRINKER FROM DRIVING!

Refer to Chapter 4 for more information about the penalties for underage drinking and driving under the influence.

DRUGS AND DRIVING

Driving impaired is both illegal and deadly. Not only does alcohol impair your ability to drive safely, many illegal, prescription, and over-the-counter drugs can also impair your ability to drive safely. Drugs other than alcohol are involved in approximately 20 percent of deaths among motorists each year. Additionally, combining drugs and alcohol further increases the side effects and greatly increases the risk of causing a crash.

Drugs affect your brain function and can seriously impair your ability to drive safely. For example, marijuana can slow reaction time, impair judgment of time and distance, and decrease coordination. Cocaine or methamphetamine can cause a driver to be aggressive and reckless when driving and certain kinds of sedatives can cause dizziness and drowsiness. Opioids can make you drowsy and can slow reaction time. Prescription and over-the-counter drugs such as sleeping pills, cough medicines, antihistamines and decongestants can affect your driving skills in a variety of ways. It is always important to review warning labels about the medication's side effects prior to driving. If you have any questions about a medication's side effects, it is important to consult with your doctor or pharmacist before driving. Remember: When the warning label states - Don't operate heavy machinery - Your vehicle is considered heavy machinery!

Click the link to learn more. <https://youtu.be/c5mNHOhcpwA>

If you are concerned about a loved one's or your own substance use, the PA Get Help Now helpline is available at 1-800-662-HELP (4357). This toll-free resource is staffed 24/7 to answer your questions and connect you to treatment providers.

DID YOU KNOW?

- According to the NHTSA 2013-2014 Roadside Survey of Alcohol and Drug Use by Drivers, nearly 1 in 4 drivers tested positive for at least one drug that could affect safe driving skills.
- 43% of drivers killed in crashes tested positive for drugs... 37% tested positive for alcohol.
- Prescription drugs can also affect driving. Talk to your doctor when starting any new medication and make sure you are aware of any potential side effects.

EVERYDAY DRIVING SKILLS

This section begins by highlighting the particular causes of crashes and major crash types among new drivers in Pennsylvania. The safe driving skills listed below are described in this section:

- Managing Space
- Managing Speed
- Turning, Merging and Passing
- Negotiating Intersections
- Negotiating Curves
- Negotiating Highways and Interchanges

Most crashes result from human error. Either the driver fails to understand how to use the vehicle or the highway system, is not paying enough attention to signs, signals, pavement markings or to the actions of other drivers, or makes poor decisions. Drivers with less than five (5) years of experience are most likely to make errors that lead to crashes.

TEEN CRASH FACT
 For 2017, 7.2% of all 16 year old Pennsylvania drivers were in reportable crashes in Pennsylvania.

• A review of the top 10 reasons new drivers in Pennsylvania (16- and 17-year-olds) ended up in crashes in 2017 is shown below. Young drivers and all drivers should be aware of these critical factors:

- **Driving too fast for conditions**
- **Proceeding without clearance after stopping**
- **Improper or careless turning**
- **Improper driving**
- **Inexperience**
- **Tailgating**
- **Speeding**
- **Over or under compensating at a curve**
- **Distractions**
- **Sudden slowing or stopping**

• The major types of crashes in which new drivers (16 and 17-year olds) in Pennsylvania are involved include:
1) Hitting a stationary object; 2) Crashes where roads intersect, like driveways, entrance ramps, and in intersections; 3) Rear-end collisions; and 4) Head on collisions. About 92 percent of all crashes and 93 percent of the deaths resulting from crashes are associated with just these four (4) crash types. Avoiding vehicle crashes depends on learning and applying the safe driving skills that are the subject of this chapter.

MANAGING SPACE

- If another driver near you makes a mistake, you will need time to react to the situation. The only way to be sure you will have enough time to react is to leave plenty of space between you and the vehicles around you.
- As shown in the diagram to the right, there are **six (6) areas of space** around your vehicle you must be able to manage.
- It is best to keep a space cushion on all sides of your vehicle.

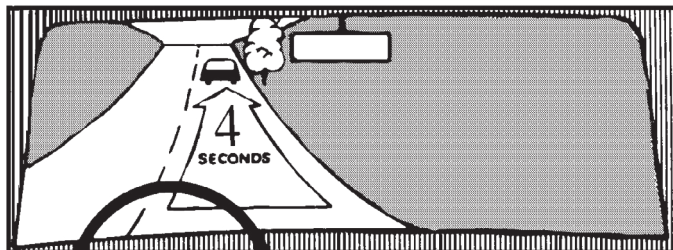
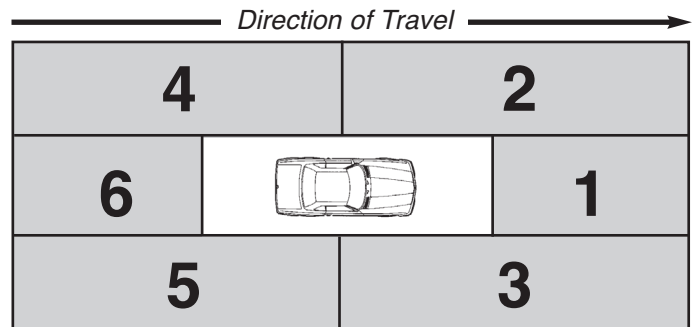

KEEP A SPACE CUSHION AHEAD (4-SECOND RULE)

- What is a safe following distance? A 4-second following distance, as shown above in **Area 1** of the space management diagram, will allow you to steer or brake to avoid a hazard safely on the highway, if the pavement is dry.
- If you are following too closely and the vehicle ahead of you stops or slows suddenly, you will not be able to avoid a crash.

- Keeping a safe following distance will enable you to react to a problem ahead without the need for a panic stop, which could cause a following driver to crash into the back of your vehicle.
- To determine your following distance, watch the rear bumper of the vehicle ahead of you. When the bumper passes a road marking or a roadside object like a telephone pole, start counting how many seconds it takes you to reach the same spot on the road. If you pass the marking or object in less than four (4) seconds, you are following too closely.

Sometimes you will need extra space ahead of you.

Allow a longer following distance than usual when:

- Traveling on roads that are wet and slippery, or not paved - there is less traction, so it takes longer to stop.
- The driver behind you wants to pass - there must be room ahead of you for the passing driver to pull in front of you.
- You are following a driver whose rear view is blocked - drivers of trucks, buses, vans, or cars pulling campers or trailers may slow down suddenly without knowing you are behind them.
- You are following a large vehicle blocking your view ahead - you need extra room to see around the vehicle.
- You are following a driver who is carrying a heavy load or pulling a trailer - the extra weight will make it more difficult to stop.
- Approaching slow moving vehicles, including bicycles.
- You are following school buses, taxis, public and private buses and trucks transporting hazardous substances - these vehicles must stop at railroad crossings and make other, unexpected stops.
- You are driving downhill - it is harder for your brakes to slow your vehicle, especially at high speeds.
- You are stopped on an uphill - the vehicle ahead may roll back into your vehicle when traffic begins to move.

KEEP A SPACE CUSHION TO THE SIDES

A space cushion to the sides, as shown in **Areas 2 and 3** of the space management diagram, will give you room to react, if another vehicle suddenly moves into your lane. These areas are your potential escape paths.

Key points to remember are:

- Avoid driving alongside other vehicles on multi-lane streets. They block your view and close your escape route, and you are probably in their blind spot.
- Keep as much space as possible to the side of your vehicle and oncoming vehicles.
- Make room for vehicles entering highways by signaling and moving to an inside lane, if it is safe.
- Keep space between your vehicle and parked vehicles. Someone may open a vehicle door or step out between parked vehicles, or a vehicle may pull out suddenly.
- If you do not have at least eight (8) feet of space on at least one side of your vehicle to use as an escape path, you will need to allow more space to the front by increasing your following distance.

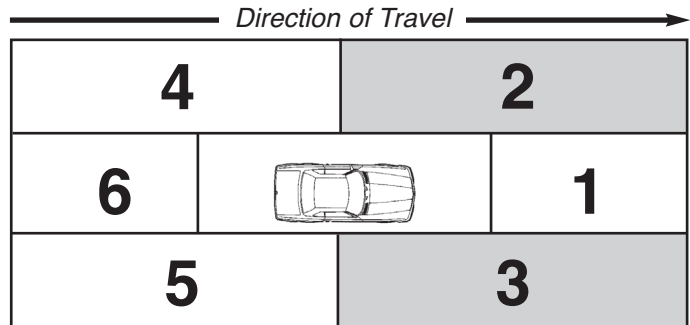

You will usually drive in the center of your lane. But sometimes, you will find dangers on both sides of the road. As in the example pictured to the right, there may be parked vehicles to your right and oncoming vehicles to your left. In this case, the best thing to do is to slow down and “split the difference” by steering a middle course between the oncoming vehicles and the parked vehicles.

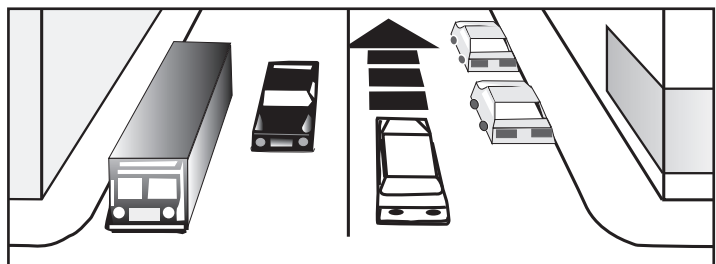

KEEP A SPACE CUSHION BEHIND

In **Area 6** in the space management diagram, a driver who is following you has more control over the clear space than you do, but you can help by keeping a steady speed and signaling before you have to slow down for a turn. If you see someone following you too closely (tailgating), move over to the right lane, if possible. If there is no right lane, you can encourage the tailgater to move around you by waiting until the road ahead is clear, then tapping your brakes gently to slowly reduce your speed. Also, look for an escape path to the side when you are preparing to slow down or stop.

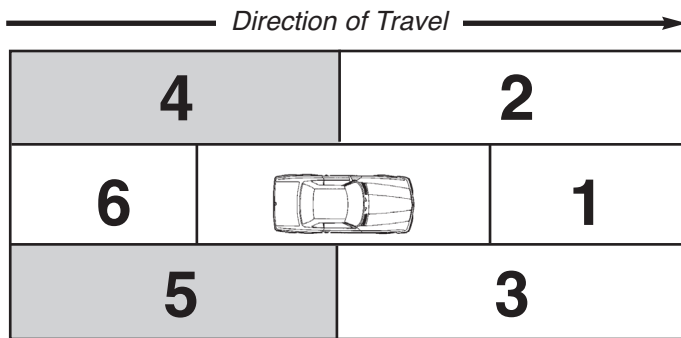
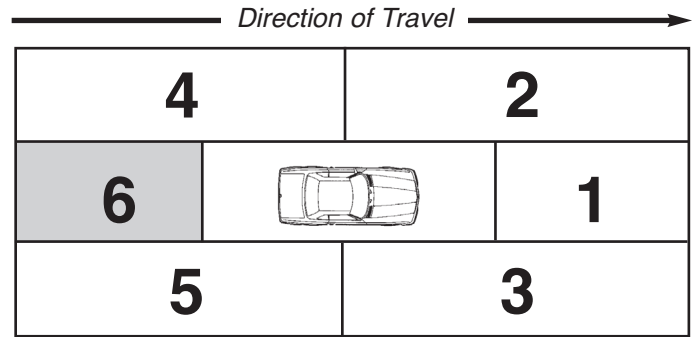

Finally, pay attention to what is happening in the left-rear and right-rear areas behind you (**Areas 4 and 5** of the space management diagram). You need to know how close other vehicles are to your vehicle and how fast they are traveling. These areas are blind spots, always check them by turning your head before changing lanes.

KEEP YOUR VEHICLE WHERE IT CAN BE SEEN

Avoid driving your vehicle in another driver's blind spot. A blind spot is any place around a vehicle a driver cannot see without moving their head. Here are some good rules to help you avoid this mistake:

- Avoid driving on either side and slightly to the rear of another vehicle for a long time. Both positions are blind spots for the other driver. Either speed up or drop back to move out of the driver's blind spot.
- When passing another vehicle, get past the other driver's blind spot as quickly and as safely as you can. The longer you stay in the blind spot, the longer you both are in danger.

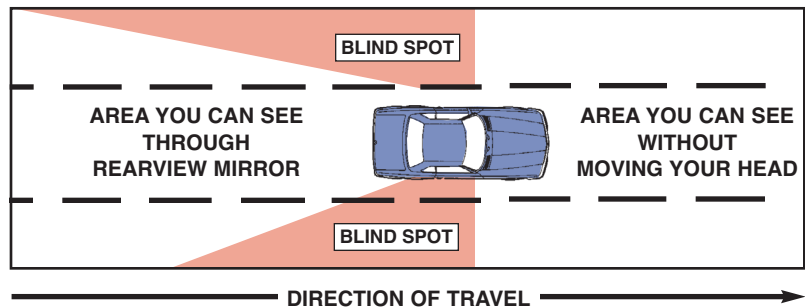

LOOKING AHEAD

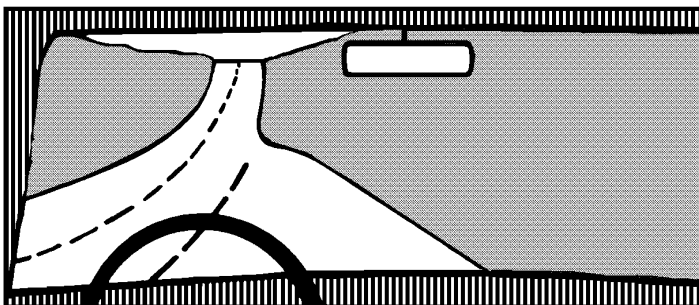

- The driver in the picture is in a lane that ends soon. If this driver does not change lanes, the driver may have to make a quick lane change or stop and wait for traffic to clear.
- To avoid last minute moves, you must look far enough ahead to see and react to things early. You should be able to identify problem situations 12 to 15 seconds ahead — about one block in the city, or a quarter of a mile at highway speeds.

Your ability to handle dangerous traffic situations depends largely on searching for and identifying problems far ahead. Looking far ahead does not mean you should simply stare at the center of the road. You need to continually scan the entire road, including the sides of the road.

As you scan the driving scene, watch for:

- Vehicles and people who enter the road ahead of you and may be moving much slower.
- A vehicle that has slowed or stopped ahead, waiting for other traffic to clear before making a turn.
- Signs warning of danger ahead.
- Signs telling you about places ahead and/or giving you information about how to reach them.

LOOKING TO THE SIDES

Looking to the sides is especially important at intersections, driveways, shopping center entrances and exits, and highway entrances and exits — any place where one stream of traffic meets another.

When you come to an intersection, follow the “left-right-left” rule:

- Look to the left first, because vehicles coming from the left are closer to you.
- Look to the right.
- Look again to the left before you pull out. You may see a vehicle you did not see the first time you looked.

When you enter the intersection, look left and right again. **Do not assume other traffic will always stop, even when there is a stop sign or signal.** If your view of the cross street is blocked by buildings, shrubs or parked vehicles, move forward slowly until you can see clearly

LOOKING BEHIND

You must also check traffic behind you as often as possible. This is very important when you are planning to change lanes or back up.

Changing lanes includes:

- Changing from one lane to another on a roadway.
- Entering a highway from an entrance lane.
- Entering the roadway from the curb or shoulder.

Before you change lanes, give the proper turn signal. Look in your rearview and side mirrors and make sure no one is going to pass you. Do not depend on mirrors or sensors alone, look over your left and right shoulders to make sure no one is in your vehicle's blind spots. Check these spots quickly. Do not take your eyes off of the road ahead for more than a second. On roads with three (3) or more lanes, check all lanes before you make a lane change — someone in another lane may also be planning to move into the same spot where you want to go.

Backing Up:

When backing up, always check behind your vehicle — do it before you get in your vehicle. Children or small objects are hard to see from the driver's seat. Before backing up, turn your head so you can see through the rear window. Do not depend on your mirrors or sensors alone.

MANAGING SPEED

What is a safe speed? How fast is too fast? There are no simple answers to these questions because there is not a single speed that is safe at all times. In addition to the posted speed limit, you must consider road conditions, visibility conditions and the flow of other traffic in choosing a safe speed to drive. Also, when you plan to change speeds, it will help you stay safe, by communicating your intentions to other drivers.

POSTED SPEED LIMITS

Posted speed limits indicate what the maximum safe driving speed is under ideal road, traffic and weather conditions.

TEEN CRASH FACT

“Driving too fast for conditions” is the No. 1 reason 16 and 17-year-old drivers are involved in crashes.

- The maximum speed limit in Pennsylvania is 70.
- The maximum speed limit on interstate highways is posted after each interchange.
- On other highways the maximum speed limit would be posted at approximately ½ mile intervals.
- In school zones, the speed limit is 15 mph when the lights on the school zone sign are flashing or during the time period indicated on signs. School zone speed limits are lower than other speed limits.

When the road is wet or slippery, when you cannot see well or when anything else makes conditions less than perfect, drive below the posted speed limit. Even if you are driving within the posted speed limit, you can still be ticketed for driving too fast for conditions.

ECO-DRIVING

Safe driving does more than protect you: it saves you money and reduces air pollution. Operating a car involves many expenses, including gas, maintenance, and tires. Drivers and car owners can take a number of steps to minimize these expenses at no additional cost.

Smart Driving Habits to Adopt

1. Slow down. Fuel consumption increases about 5% for every five miles per hour driven above 60 mph.
2. Ease up on the pedals. Rapid starts and hard stops can increase fuel usage by 40%, but reduce travel time by only 4%.
3. Drive cool. Avoid driving during the hottest parts of the day. Cooler, denser air can boost power and mileage.
4. Stay cool. Use your car's air conditioner when driving more than 40 mph.
5. Drive to warm up. Even on the coldest days, it only take 30 seconds to get your vehicle ready to drive.
6. Keep cruising. Get a 7% average fuel savings by using cruise control while driving on flat highways.
7. Follow the light. When your vehicle's on-board diagnostics (OBD) light turns on, it is possible that fuel economy is decreasing and emissions are increasing. If the OBD light comes on, talk with your auto dealer for more information.
8. Drive safely. Keep enough distance between you and other vehicles. Doing so not only protects you, it also prevents wear and tear on your vehicle.
9. Utilize your car. If your vehicle has an "ECO" setting, use it. It will smooth out your gas pedal inputs, optimize transmission shift points, and decrease the impact of air conditioner on the engine.
10. Turn it off. Idling wastes fuel and may be prohibited. If you need to idle, shift to neutral or park so the engine is not working against your brake and consuming more fuel.
11. Drive less. There are multiple ways to reduce costs and save money by driving less. Take public transportation, bicycle or walk, or carpool. Additionally, combining errands saves time and gas.
12. Educate yourself. There are many resources available to get and stay educated about the best safe driving practices.

DRIVING AT NIGHT

The highest crash rates occur during nighttime hours. Most serious crashes occur in twilight or darkness. Overall, traffic fatality rates are three (3) to four (4) times higher at night than in daylight. Compared to driving in the day, driving at night is more dangerous.

There are several reasons for this:

- Your vision is severely limited at night.
- Glare from other vehicles' headlights may temporarily blind you.
- More people who are tired or who are driving under the influence are likely to be on the road at night.

With less light, your ability to judge distances is reduced, your ability to see colors is reduced, and your ability to see things in your side vision is reduced. As a driver, you must always be ready to react if you suddenly see something unexpected on the road ahead of you — a pedestrian, a bicyclist, an animal, etc. — and you are much more likely to be surprised at night. Compared to signs and other roadside objects, pedestrians are hardest to see at night.

You must use your headlights properly at night and other times, as required by law. Headlights have a dual purpose: to help you see and to help you be seen. Clean your headlights at least once a week. Do it when you buy gas for your vehicle — dirty headlights may give only half of the light they should.

State law requires drivers to use their headlights:

- When they cannot see because of insufficient light on gray days or in heavy traffic when their vehicle may seem to blend in with the surroundings.
- When there are unfavorable atmospheric conditions, including rain, snow, sleet, hail, fog, smoke or smog. In bad weather, use only low beams. High beams actually reduce visibility under these conditions.
- When they cannot see pedestrians or vehicles on the highway for a distance of 1,000 feet ahead of the vehicle they are operating.
- Between sunset and sunrise.
- When driving through work zones.
- Anytime your vehicle's wipers are in continuous or intermittent use due to weather conditions.

NOTE: Daytime running lights are not enough. Your tail lights must be illuminated as well.

State law calls for fines beginning at \$25 and with other associated costs, the penalty would approach \$100 for drivers who fail to use their headlights when required!

Other important safety information about headlights and nighttime driving:

- When driving at night, use low beams as soon as you see another vehicle approaching in the oncoming lane, as high beams can “blind” the other driver. Pennsylvania law requires you use low beams whenever you are within 500 feet of an oncoming vehicle and when you are following a vehicle within 300 feet.
- If a vehicle using high beams comes toward you, flash your high beams quickly a few times. If the driver does not dim their lights, look toward the right side of the road. This will keep you from being “blinded” by the other vehicle's headlights and will allow you to see well enough to stay on your course until the vehicle passes.
- Do not try to punish the other driver by keeping your bright lights on. If you do, both of you may be “blinded.”
- If glare from a following vehicle's headlights is uncomfortable because it is reflecting in your rearview mirror, you can switch the inside rearview mirror from its daytime to nighttime setting.
- Do not “overdrive your headlights” by driving so fast you could not stop in time to avoid a hazard that appears within the length of road ahead lighted by your headlights. Low beam headlights shine only about 250 feet ahead. Even on dry pavement, it takes more than 250 feet to stop if you are moving at 55 mph. To avoid overdriving your headlights on a dark road at night, you should not drive faster than 45 mph.

ROAD CONDITIONS

Your ability to stop is greatly affected by the condition of the road. You need to reduce your speed when road conditions are poor, so you can maintain control of your vehicle. You will be at greatest risk if you drive too fast on roads that are slippery, especially on curves. **Take turns and curves more slowly when the road is slippery.**

• **Wet Pavements**

All roads are slippery when wet, but be extra careful on roads posted with warning signs that say **SLIPPERY WHEN WET**. Pavements can become very slippery in the first 10 to 15 minutes of a rain storm. The rain

causes oil in the asphalt to come to the surface. This problem becomes even worse during hot weather, when the heat combined with the water causes more oil to rise to the road surface. In cold, wet weather, be extra careful driving on sections of road shaded by trees or buildings; these areas freeze more quickly and dry last.

- **Hydroplaning**

At excessive speeds, your vehicle can begin to hydroplane on a wet roadway. Hydroplaning happens when your tires lose their grip on the road and ride like skis on a film of water. The faster you drive on a wet roadway, the less effective your tires become at wiping the water from the road. You can hydroplane at speeds as low as 35 mph, when water is only 1/10 of an inch deep. Worn tires make this problem worse. Hydroplaning can be reduced by driving slower.

If you find yourself hydroplaning, do the following:

1. Keep both hands on the steering wheel.
2. Slowly take your foot off of the gas pedal to let your vehicle slow down. Do not slam on the brakes or try to turn suddenly because this will cause your vehicle to skid. As your vehicle slows down, the amount of tire tread touching the road will increase, and you'll begin to get better traction.
3. Turn slowly and only as much as necessary to keep your vehicle on the road.
4. If you have to use your brakes, brake gently. (*Refer to the section "If you have to brake suddenly", later in this chapter for important information about using conventional versus anti-lock brakes in emergency stops.*)

- **Snow and Ice**

When driving on snow or ice, you will need to adjust your driving to accommodate any situation. The traction of your tires on the road will be greatly reduced, seriously affecting your steering and braking ability. Also, it is extremely dangerous near 32° (Fahrenheit), when precipitation turns to rain or sleet — a thin layer of water on top of ice is more slippery than ice alone.

Watch for "black ice," a condition occurring on clear roadways when a thin layer of ice forms due to dropping temperatures. When the road looks wet but no spray is coming from the tires of other vehicles, "black ice" may be present.

Under law, which went into effect July 10, 2006, motorists will face severe fines if snow or ice that falls from their vehicle causes injury or death to other motorists or pedestrians. When snow or ice is dislodged or falls from a moving vehicle and strikes another vehicle or pedestrian causing death or serious bodily injury, the operator of the vehicle from which the snow or ice came is subject to a fine of \$200 to \$1,000 for each offense. PennDOT urges motorists to remove all ice and snow from their vehicles before traveling.

When roads get slick, you should:

- Reduce your speed by 5 to 10 mph on wet roads and increase your following distance to five (5) or six (6) seconds.
- On ice or snow covered roads you need to slow down even more. On packed snow, decrease your speed by half; on ice, slow to a crawl. Leave about 10 times more space than normal between you and the vehicle ahead.
- Apply brakes gently, ease off if you start to skid and reapply when you regain control. (*Refer to this section "If you have to brake suddenly", later in this chapter for important information about using conventional versus anti-lock brakes in emergency stops.*)
- Do not use your cruise control when driving on slippery roads. Snow, ice, slush and rain can cause wheel-spin and loss of control. The only way to stop wheel spin and regain control is to reduce power. But, an activated cruise control system will continue to apply power, keeping your wheels spinning.
- Adjust your speed to avoid meeting other vehicles at slippery areas, such as shady spots and frost on bridges during cold weather. This will reduce the risk of skidding into the other vehicle.
- On icy or snow-packed roads, try to time your arrival at an intersection by letting your vehicle coast until the light turns green and vehicles ahead of you have begun to move. This way, you will not have to brake to stop and then accelerate to begin again. Also, when going uphill, stay far enough behind the vehicle ahead, so you will not need to slow down or stop. Before starting downhill, shift to a lower gear for better control.

VISIBILITY CONDITIONS

In addition to nighttime, fog and snow are conditions that reduce visibility and can dramatically decrease your ability to see ahead, and to respond quickly and safely to events happening around you.

Fog is probably the most dangerous driving environment. You cannot see what you are about to hit, and others cannot see you either.

Do not start a trip if the fog is so dense you cannot see. If you get caught in dense fog, it's best to pull completely off of the road, preferably into a parking lot, to wait until the fog clears. While parked, turn your hazard lights on to make your vehicle more visible, and keep your seat belt fastened.

When you must drive in FOGGY CONDITIONS, always remember to do these two (2) things

- | | |
|---|--|
| <p>1. Slow down enough so you can stop safely within the distance that you can see. You will need to carefully check your speedometer because fog takes away most of the visual information that lets you know how fast you are going; this makes it easy for you to speed up without being aware of it.</p> | <p>2. Turn on your low beam headlights (and fog lights, if your vehicle has them) so others can see you. Do this whether it is daytime or nighttime. Do not use your high beams. They direct their light up and into the fog, which bounces the light back into your eyes, creating glare and making it even harder for you to see ahead.</p> |
|---|--|

Snow also can severely limit your visibility.

To increase your ability to see when driving in SNOWY CONDITIONS, do these six (6) things

- | | |
|--|--|
| <p>1. Clear all the windows, hood, trunk and roof of your vehicle before starting to drive in the snow. If you don't, snow will blow off of your vehicle and onto your windshield, blocking your view, or could blow off and onto the windshield of a driver who is following you.</p> <p>If snow or ice from a moving vehicle strikes another vehicle or pedestrian causing death or serious bodily injury, the vehicle's driver could be fined.</p> <p>2. Clear your headlights, taillights and directional signals of snow, ice and dirt. This helps other drivers see you and helps you see what is ahead. A dirty headlight reduces light output by more than 50 percent.</p> <p>3. Let the engine warm up before you start driving. It gives the defroster a chance to warm the windshield and melt any ice you could not scrape off.</p> | <p>4. Use your windshield wipers to keep your windshield as clear as possible. Make sure your windshield washer reservoir is full, and you are using fluid that will not freeze.</p> <p>5. Keep the defroster on to clear steamed windows. If you have a newer vehicle, your defroster may be part of your air conditioning system. Read your owner's manual to learn how your vehicle's defroster settings should be used.</p> <p>6. Turn on your low beams, even during the daytime. This increases your visibility to other drivers.</p> |
|--|--|

SNOW SQUALLS

Snow squalls are a dangerous winter driving hazard. Snow squalls most often happen on clear and otherwise pleasant driving days, when an intense snow burst reduces visibility to near zero and slickens the roadway in a matter of seconds. As a driver, you may go from clear and dry roadways to dangerous conditions in an instant, leaving little time to react often at speeds in excess of 60mph on interstates. These squall events have a history

or producing multiple vehicle accidents on Pennsylvania roadways, with numerous injuries and deaths. Below are some tips for drivers for snow squalls:

- **MONITOR:** Watch the forecast if you plan to travel. The National Weather Service and broadcast partners will try to alert drivers in advance on days where squalls will be possible. Monitor transportation message boards and signs for any approaching hazards.
- **PLAN:** Adjust your travel plan by either time, route, or both to avoid squalls. Interstates are often the greatest risk due to high-speed travel and increased traffic.
- **AVOID:** If you're driving and you see an approaching squall or know squalls are near, exit the roadway and wait for the squall to pass.
- **CAUTION:** If you encounter a snow squall, exercise extreme caution by gradually slowing and activating your hazard lights for increased visibility. Do not slam on your brakes. If you are involved in a collision, whenever possible, stay in your vehicle.

The National Weather Service now issues "Snow Squall Warning" messages for specific roadways where these dangerous squalls are likely to cause a great impact to drivers, typically lasting less 45 minutes for a roadway. Drivers can sign up to receive these alerts, and other weather alerts, via text message or applications from many third-party vendors. If you receive a Snow Squall Warning for your travel route, follow the above steps to delay or alter your travel plans.

HEADLIGHT/WINDSHIELD WIPER LAW

This law, which went into effect Jan. 28, 2007, requires motorists to turn on their headlights anytime their vehicles wipers are in continuous or intermittent use due to weather conditions. Daytime running lights are not enough. Your tail lights must be illuminated as well. Motorists who do not comply with the law may face a fine of \$25, but with fees and other associated costs, the penalty would approach \$100.

TRAFFIC FLOW

- Crashes often happen when some drivers go faster or slower than other vehicles on the road. Always try to drive with the flow of traffic within the posted speed limit.
- You may need to adjust your speed to maintain your space cushion depending on what traffic is doing around you. For example, when traveling in a pack of vehicles on a highway, you will often find yourself traveling in someone's blind spot with no space cushion for emergencies. When this happens, reducing your speed by just two (2) or three (3) mph will encourage traffic around you to clear out, so you are no longer closed in.
- Another time when you may have to adjust to traffic flow is if there is more than one (1) potential hazard ahead you will confront at the same time. For example, with a bicyclist to your right, the safe thing to do is to move **left** to allow a wide margin when you pass. But, if there is also an oncoming vehicle, this creates a problem because normally you would want to move to the **right** in your lane in this circumstance. You should handle this situation by facing only one (1) traffic condition at a time. Slow down to let the oncoming vehicle pass and then move left to pass the cyclist, leaving a sufficient amount of space for safety.
- Also, when you are approaching an emergency scene, police stop or a tow truck picking up a disabled vehicle, you must move into a nonadjacent lane. If you cannot move over, you must reduce your speed to at least 20 miles per hour below the posted speed limit.

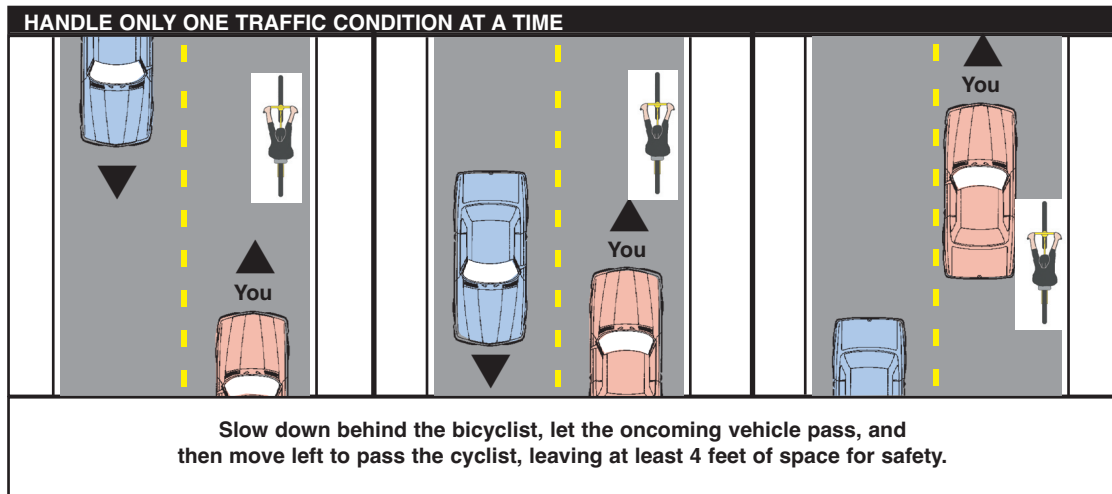

REACTIONS TO SLOW MOVING TRAFFIC

Watch out for vehicles that have trouble keeping up with the flow of other traffic and when entering the roadway; they take longer to pick up speed. These include some large trucks, as well as farm equipment and horse-drawn vehicles. Trucks, especially on long or steep upgrades, typically use their flashers to alert other drivers they are moving slowly.

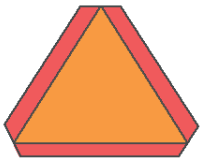

In rural areas, an orange triangle is displayed on the back of farm tractors and horse-drawn vehicles designed to operate at 25 mph or less; this is a slower speed than traffic normally travels. In certain areas of Pennsylvania, it is not at all unusual to find yourself sharing the road with farm tractors and horse-drawn vehicles. Stay a safe distance back, and do not honk to pass.

COMMUNICATING YOUR INTENTIONS TO OTHER DRIVERS

Crashes often happen because one (1) driver does something that another driver does not expect. To help avoid crashes, communicate with drivers on the road.

Let others know where you are and what you plan to do by:

- **Signaling when slowing down or stopping.** Your brake lights tell other drivers you are slowing down or stopping. If you are going to brake where other drivers may not expect it, quickly tap your brake pedal three (3) or four (4) times. If you must drive below 40 mph on a limited access highway, use your hazard (four-way) flashers to warn the drivers behind you.

- **Signaling when changing direction.** Signaling tells others you want to make a turn, but it does not give you the right to make a turn. Under Pennsylvania law, you must always use your turn signals at least **100 feet** before turning, if you are driving less than 35 mph. If you are driving 35 mph or more, you must signal at least **300 feet** before turning. If your vehicle's turn signals do not work, use these hand signals.

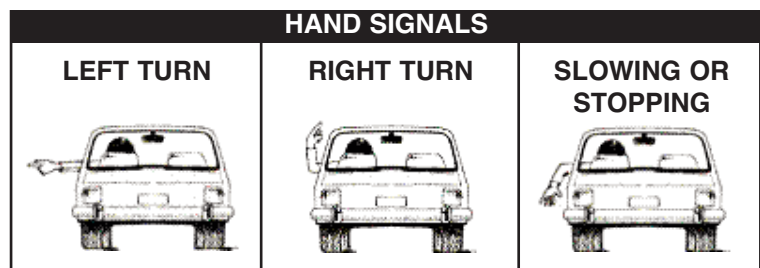

- **Using emergency signals.** If your vehicle breaks down on the highway, you will need to pull off of the road. Signal, then carefully exit the roadway, and put on your hazard (four-way) flashers to warn other drivers. Get as far off of the road as possible, and park in a place where other drivers can see you easily. Lift your hood to let other drivers know your vehicle is disabled.
- **Using your horn.** Your horn instantly attracts the attention of other drivers. Use it when you think another driver or a pedestrian does not see you – for example, if a child is beginning to run into the street or if you think another vehicle is about to hit you. Also, if you lose control of your vehicle, alert other drivers by sounding your horn.

TURNING, MERGING AND PASSING

You must concentrate on many factors when making a turn. Speed is probably the most important factor. When turning, reduce to a speed that allows you to maintain control of your vehicle, allows you to stay in your lane during the turn and allows you to react to unexpected situations. Watch out for pedestrians and for other traffic in the street you are turning onto. Many streets have signs, signals or markings to guide you. Some signs show what lanes you can or must use for turns.

TO COMPLETE A TURN SAFELY

1. **Signal three (3) to four (4) seconds before your turn.**
2. **Position your vehicle in the proper lane.**
3. **Control your speed.**
4. **Complete your turn in the proper lane.**

TEEN CRASH FACT

Improper or careless turning is a common cause of crashes among new, young drivers. In 2017, improper or careless turning was a factor contributing to 459 crashes involving drivers age 17 in Pennsylvania.

LEFT AND RIGHT TURNS

On two-lane, two-way streets or highways, make left turns from as close to the centerline as possible. Make right turns from as close to the right edge of the roadway as possible.

To turn left on multi-lane streets and highways, start from the left lane. If you are turning right, start from the right lane. If you are turning onto a highway, which has more than one (1) lane in the direction you wish to travel, turn into the closest lane going in that direction. Turn into the left lane when making a left turn, and turn into the right lane when making a right turn. If you want to change to another lane, wait until after you have safely completed your turn.

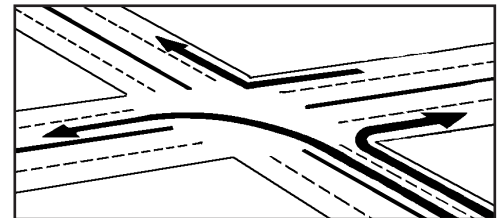

TURNING FROM OR INTO A CENTER TURN LANE

If you see a lane in the middle of a two-way street marked on both sides by two (2) lines — one (1) solid outer line and one (1) broken inner line — it means this lane may only be used for left turns (Refer to the diagram in Chapter 2). Drivers traveling in either direction must use this lane to begin their left turns, and drivers entering the road may also use this lane to end their left turn from a cross street before entering the traffic stream.

There are many possible traffic conflicts in this situation:

- When you enter the center lane to turn left into a driveway or cross street, you must watch for both oncoming vehicles in the center turn lane and vehicles turning from driveways and cross streets (on your left) into the center turn lane.
- When you are turning left from a driveway or cross street into a center lane, you must watch for through traffic coming from your left, as well as for drivers who are already in the center lane preparing to make a turn from either direction.

FOLLOW THE GUIDELINES BELOW TO SAFELY USE CENTER TURN LANES

1. **Put on your left turn signal** at least three (3) to four (4) seconds before entering the left-turn lane.
2. **Do not get into the center turn lane too soon.** The longer you drive in the center lane, the more likely you are to meet someone head-on coming from the other direction.
3. **When you enter the center turn lane, enter it completely.** Do not leave the back end of your vehicle sticking into the normal travel lane, blocking traffic.
4. **Turn only when it is safe.** Look for vehicles coming toward you in the same lane, and make sure there is a big enough gap before you turn across oncoming traffic. If entering the center lane from a cross street, watch for through traffic and for center lane traffic preparing to turn.

**U-TURNS**

These are permitted only if they can be made without endangering other traffic. In choosing a place to make a U-turn, make sure drivers coming from all directions are at least 500 feet away from you, and they can see you clearly. U-turns are not allowed on curves or when you are approaching or nearing the crest of a hill. U-turns are also illegal at locations marked with this sign.

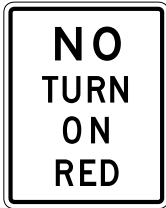
**TURNING RIGHT AT A RED LIGHT**

Unless you see this sign, you may turn right at a red light if traffic is clear. Before making the right turn, you must always stop first, and yield to pedestrians and cross traffic. If you are turning from a one-way street onto another one-way street, you may also turn left on a red signal after stopping, if traffic is clear and there is not a **NO TURN ON RED** sign. This sign is typically placed beside the road on the near side of the intersection and close to the traffic signal on the far side of the intersection.

CROSSING TRAFFIC

Whenever you cross traffic, you need enough space to do it safely. The amount of space you need to cross traffic depends on the road, weather conditions and oncoming traffic.

Remember:

- Stopping halfway across a street is safe only when there is a turning lane provided in the center median large enough to hold your entire vehicle.
- If you are crossing or turning, make sure there are no vehicles or pedestrians blocking your path. You do not want to be caught in the middle of an intersection with traffic coming toward you.
- Even if you have a green light, do not enter an intersection if there are vehicles blocking your way. Wait until you are sure you can clear the intersection before starting to cross it.
- Do not pull out in front of an approaching vehicle with its turn signal on to enter or to cross a street. The driver may plan to turn into a street or driveway just beyond you, may have changed their mind or may have forgotten to turn off the signal. This is especially true of motorcycles; their signals may not turn themselves off.
Wait until the other driver actually starts to turn before you go.
- Use extra caution when crossing traffic in areas with hills or curves, where you cannot see or be seen as well.

MERGING WITH TRAFFIC

Merging with traffic also demands good driver judgment. Whether you are changing lanes on a highway or entering a highway from a ramp, you need enough space to move safely into the traffic stream.

Entrance ramps for highways often have acceleration lanes. These lanes run beside main traffic lanes and should be long enough to allow you to accelerate to the speed of traffic before you enter the highway itself. These lanes also allow drivers on the highway to see you before you enter the road. **It is illegal to pass a vehicle ahead of you in an acceleration lane.**

Follow These Three Steps to Merge with Traffic from an Acceleration Lane
<ol style="list-style-type: none"> 1. Put your turn signal on, and look for an opening in traffic. 2. Accelerate up to the speed of traffic. 3. Merge into the opening in traffic.

PASSING

Passing is an important part of driving; if not done properly, passing can be a very dangerous or even fatal maneuver. Use the following guidelines.

In general, if there is enough clear road ahead of you to attempt a pass, you still must

1. Look for signs and pavement markings that tell you when you can or cannot pass safely under normal driving conditions. (*Examples of these can be found in Chapter 2.*)
2. Look ahead carefully before you start to pass and check for any dangers in the passing area, such as driveways from which a vehicle could enter the roadway during your passing maneuver.
3. Look in your side and rearview mirrors and quickly check your blind spots to make sure there are no vehicles about to pass you when you start to pass.
4. Before passing, make sure the passing lane is clear and give the proper turn signal to show you are going to change lanes. Signal early enough so others will know your plans in advance.
5. After passing, signal your plan to return to your lane.
6. Before you move back into the lane, make sure you can see both headlights on the front of the vehicle you passed in your rearview mirror.

When passing, be extra careful in areas where vehicles or pedestrians might enter or cross the road. These places include crossroads and shopping center entrances and exits. Also, a driver turning onto the roadway and into the left lane will not expect to find you in that lane and may not even look your way.

- **ON A TWO-LANE ROAD**

Passing on a two-lane road requires good judgment to avoid a head-on collision because you must use a lane belonging to oncoming traffic. At 45 mph, this translates into 1/4 mile of clear roadway you need to safely pass a slower vehicle.

You need to be going about 10 mph faster than the vehicle(s) you are passing. If there are other vehicles ahead of the vehicle you want to pass, you may pass them as well, but make sure you have a large enough space in front of that vehicle to move into before you begin your passing maneuver.

It is most dangerous to pass at night because you cannot see as far ahead, and it is more difficult to accurately judge distances. If you can only see the headlights of an oncoming vehicle, you are likely to think it is farther away than it really is.

- **PASSING ON THE RIGHT**

Under certain conditions, you may pass another vehicle on the right:

- When the driver you are passing is making or signaling a left turn, the driver of the passing vehicle must stay on the berm or shoulder.
- When driving on a roadway with two (2) or more marked traffic lanes in each direction.

- **YOU MAY NOT PASS IF:**

- You are within 100 feet of or are crossing any intersection or railroad grade crossing, unless an official traffic control device says you may.
- You are within 100 feet of any bridge, elevated structure or tunnel.
- You are approaching or are on a curve or a hill crest (top) restricting your view of oncoming traffic.
- You are on the shoulder of a multi-lane highway.

TEEN CRASH FACT

Driving on the wrong side of the road is a frequent factor contributing to crashes among 16- and 17-year-old drivers. From 2013 to 2017, there were 384 crashes and 15 people killed.

NEGOTIATING INTERSECTIONS

The law does not give anyone the right-of-way at intersections; it only says who must yield. Even when one driver is legally required to yield right-of-way, if they fail to do so, other drivers are still required to stop or yield as necessary to avoid a crash. **Never** insist on having the right-of-way; it may result in a crash.

Laws governing who must yield in different driving situations are listed below. You must follow these laws, if there are no signs, signals or police present to tell you what to do at the intersection:

1. Drivers must yield to pedestrians when they are: **a)** crossing at any intersection without a traffic light (with or without a crosswalk); **b)** crossing the roadway in marked crosswalks, whether or not at an intersection; **c)** walking on a sidewalk crossing a driveway or alley; and **d)** when the driver is turning a corner and pedestrians are crossing with the light. Drivers must always yield to any blind pedestrian carrying a white cane or being led by a guide dog.
2. Drivers turning left must yield to oncoming vehicles going straight ahead.
3. Drivers entering a circular intersection (or roundabout) must yield the right-of-way to drivers already in the circle.
4. When two vehicles approach or enter an intersection from different roadways at or about the same time, drivers coming from the left must yield to vehicles coming from the right.
5. A vehicle entering a public highway from an alley, private road or driveway must wait until the main road is clear.
6. At a four-way stop, all vehicles must stop. The first vehicle to reach the intersection should move forward first. If two (2) vehicles reach the intersection at the same time, the driver on the left yields to the driver on the right. If facing one another both can proceed with caution, watching for possible turns.

TEEN CRASH FACT

Intersections are places where teenage drivers have a high percentage of their crashes. In over one-third (1/3) of the crashes involving 16-year-old drivers in Pennsylvania, the teen driver was pulling out from a stop sign or turning left across traffic.

APPROACHING INTERSECTIONS

As you approach an intersection, look for signs, signals and pavement markings telling you what movements are allowed from which lanes. Get into the correct position to turn or to travel through the intersection well in advance.

Signs and pavement markings for lane assignment

Many streets have signs or pavement markings indicating a particular lane is to be used for a particular traffic movement. If you end up in a lane marked for turns only when you want to go straight through the intersection, you must make the turn. If you want to turn, but end up in a lane marked for through traffic, you must continue straight through the intersection. At the intersection shown on the right, the signs and markings tell you if you are in the right lane, you may only turn right, and if you are in the left lane, you may either turn left or go straight through the intersection.

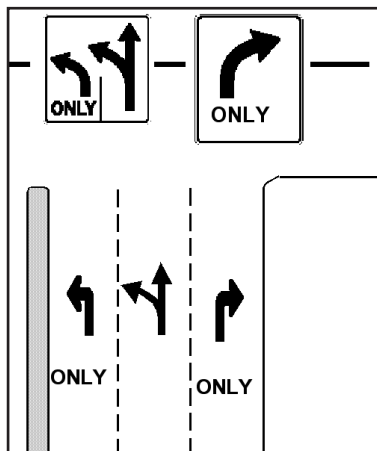

The signs and markings in the diagram shown to the left, include dual left turn lanes. You may turn left from either lane, but the driver next to you may turn left at the same time. Do not change lanes during the turn, as this will cause you to crash into the driver turning next to you. Also, watch out for the driver next to you straying into your

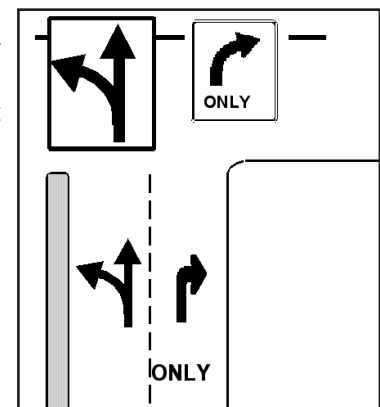

turning path. The signs and markings here indicate you must turn right if you are in the right lane. If you are in the left lane, you must turn left. If you are in the center lane, you may either turn left or go straight through the intersection.

TRAFFIC SIGNALS AND STOP SIGNS

Your safety at intersections depends a lot on your proper response to the green, yellow and red lights you see on traffic signals and to two-way and four-way stop signs.

ONE WAY, WRONG WAY AND DO NOT ENTER SIGNS

Many streets in cities are one-way streets. You will know traffic on a particular street moves in only one (1) direction if you see **ONE WAY** signs posted at the intersection. Another clue a road is one way is when you see vehicles parked on both sides of the road headed in the same direction.

You will see **ONE WAY** signs, **WRONG WAY** signs and **DO NOT ENTER** signs all together at roads intersecting with divided highways. You can think of a divided highway as two (2), one-way streets. Most have a physical barrier separating traffic moving in each direction. This could be a narrow concrete barrier, or it could be a wide cement or grassy area. You will usually see a **DIVIDED HIGHWAY** sign on your road as you approach the intersection.

Making a right turn onto a divided highway is no different from making a right turn at any other intersection. Make sure you have a safe gap to turn right in front of traffic approaching from your left.

There is a special danger in making a left turn onto a divided highway, however. If you do not realize you are turning onto a divided highway, you may turn left before you get to the physical divider and end up in a head-on collision with traffic approaching from your left. You must take notice of the **DO NOT ENTER** and **WRONG WAY** signs.

To correctly turn left onto a divided highway, you need to cross the "first" roadway when there is a safe gap in traffic approaching from your left, and then turn left on the other side of the barrier, when there is a safe gap in traffic approaching from the right on the "second" roadway.

MOVING INTO AND THROUGH INTERSECTIONS SAFELY

- **To travel across an intersection with a two-way stop sign** - You need about a 6-second gap in both directions to cross a 30 mph street or about a block of clear space to the right and left. At the stop sign, first look to the left, then look to your right for a safe gap, and then quickly check to your left again before proceeding.
- **To turn right** - Look left, straight ahead, right and then left again to make sure there is no traffic coming. Allow a gap of about eight (8) seconds between you and any vehicle approaching from the left.
- **To turn left** - Make sure you have a clear gap to turn in front of oncoming traffic and traffic on the cross street is stopped. If you are turning from a minor onto a major street, allow a 9-second gap between you and any vehicle approaching from the right.

It is important when turning left to avoid conflicts with vehicles turning left from the opposite direction. In the diagram at the right, imagine an "X" at the center of the intersection. By turning before you reach the "X," you avoid a "tangle turn" with the other left-turning driver. By always turning into the lane closest to the centerline, you also avoid interfering with traffic coming from the opposite direction making a right turn onto the same street.

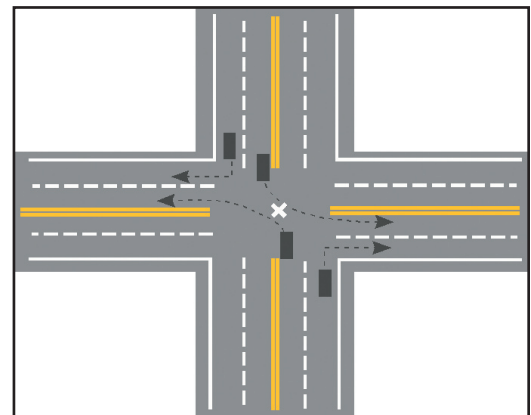

Most important: Never start a left turn until you can see all the lanes you need to cross are clear, and you can safely make the turn.

- **Jughandles** - Some roads in busy, commercial areas have a physical barrier dividing traffic moving in opposite directions and signs at the signalized intersections saying **NO LEFT TURN** or **NO U-TURN** and **ALL TURNS FROM RIGHT LANE**. In this situation, the road may be designed with jughandles for making left turns. Instead of making a left turn directly across oncoming traffic, you will use a right turn lane curving back to intersect the major road at a traffic light then turn left.
- **Circular Intersections** - Roundabouts and traffic circles are circular intersections where traffic moves counter-clockwise, so that all turns into and out of the circle are right turns. This eliminates the risk of head-on, left-turn and right-angle crashes. Roundabouts have special rules and a special design making them different from traffic circles, however.

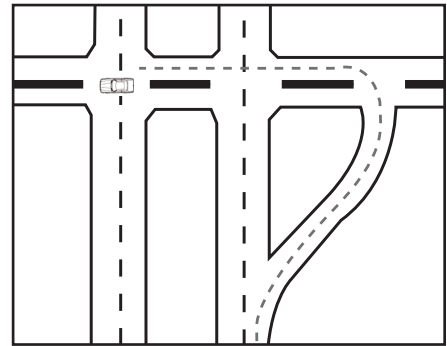

We will focus on how to use roundabouts since these kinds of circular intersections are replacing the large, old-fashioned and high-speed traffic circles or are being installed in many communities instead of intersections with traffic signals primarily due to their safety and operational benefits. Roundabouts are sometimes installed at the end of the ramp of interchanges.

Roundabouts have **YIELD** signs at each entry point and yield lines painted on the pavement at each entry point. Most roundabouts also have a destination sign on the approach so you know where each exiting road will take you.

DID YOU KNOW?

The most frequent cause of crashes at roundabouts is drivers who fail to yield before they enter.

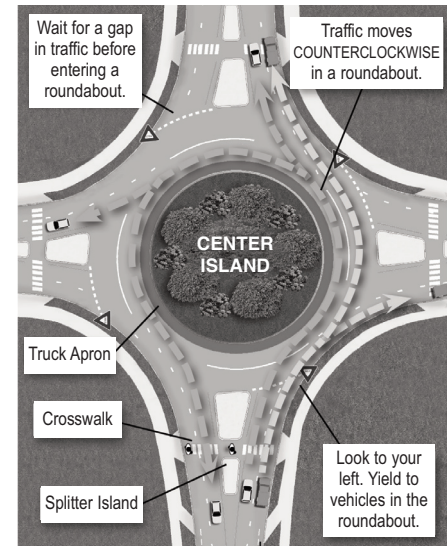

HOW TO USE A CIRCULAR INTERSECTION

APPROACHING AND ENTERING:

1. When approaching a roundabout **SLOW DOWN** and be prepared to yield to pedestrians in the crosswalk.
2. Pull up to the Yield Line, look to the left and check for approaching traffic within the roundabout, **CIRCULATING TRAFFIC HAS THE RIGHT- OF-WAY**.
3. Enter the roundabout when there is an adequate gap in traffic.

EXITING THE ROUNDABOUT:

1. Once you have entered the roundabout, proceed counterclockwise to your exit point. **YOU** now have the right-of-way.
2. As you approach your exit, use your **RIGHT TURN SIGNAL**.
3. Watch for pedestrians in the crosswalk and be prepared to yield.
4. Exit the roundabout.

BE PREPARED FOR:

Emergency vehicles - Do not enter the roundabout when emergency vehicles are approaching, pull to the side. If in the roundabout, immediately exit the roundabout and pull to the side. **NEVER STOP IN THE ROUNDABOUT.**

Bicyclists - Bicyclists have the option to function as a vehicle or pedestrian when using a roundabout. When acting as a vehicle, they will follow the same rules. **NEVER OVERTAKE A BICYCLIST ACTING AS A VEHICLE IN A ROUNDABOUT.**

Pedestrians - Motorists must yield to pedestrians when entering and exiting a roundabout. Pedestrians will utilize crosswalks and splitter islands to cross each leg of the roundabout.

NEGOTIATING CURVES

The most important thing to understand about curves is you cannot beat the laws of physics. Vehicles are heavy, and they have lots of inertia. This means if you are driving too fast on a curve, your vehicle is going to keep moving straight ahead instead of around the curve, no matter how much you try to steer it or slow it down to keep it in your lane. You will either run off of the road (on a left-bending curve) or go into the other lane of traffic (on a right-bending curve). You do not have to be traveling very fast for this to happen. If the curve is sharp and the road is wet or icy the most reduction in speed is needed.

TEEN CRASH FACT

The most frequent crash type for 16-year-old drivers in Pennsylvania is a **single-vehicle, run-off-the-road crash**. From 2013 to 2017, there were 3,291 crashes and 20 people killed.



TO MAINTAIN CONTROL ON CURVES, YOU MUST SLOW DOWN. DO IT BEFORE YOU ENTER THE CURVE.

As you approach a curve, you will usually see a yellow diamond warning sign showing how the road bends. If the road bends at a 90-degree angle, you may see a rectangular yellow sign with a large arrow pointing left or right. Some sharp curves also have chevron warning signs placed throughout the turn; these are very helpful at night or in poor visibility conditions. Review the various types of curve warning signs shown in Chapter 2.

HERE IS HOW YOU CAN SAFELY DRIVE THROUGH CURVES:

1. Keep slightly to the right of the lane center on right curves and in the middle of your lane on left curves.
2. The sharper the curve, the more you need to reduce your speed.
3. Look for traffic coming from the opposite direction. A speeder could easily stray into your lane.
4. For guidance about how to steer your vehicle, scan ahead and look at the inside edge of the curve. If there are multiple curves, look at the inside edge of each curve as far ahead as you can see.

THE PHYSICS OF SPEEDING ON A LEFT-BENDING CURVE

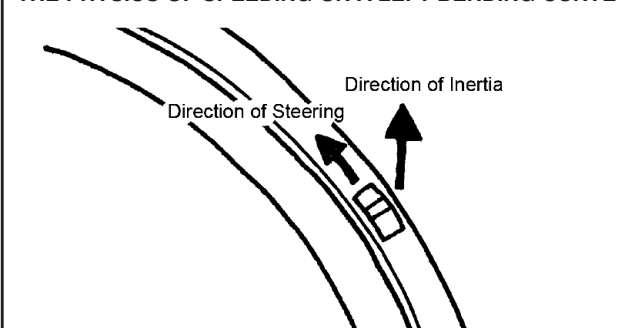

THE PHYSICS OF SPEEDING ON A RIGHT-BENDING CURVE

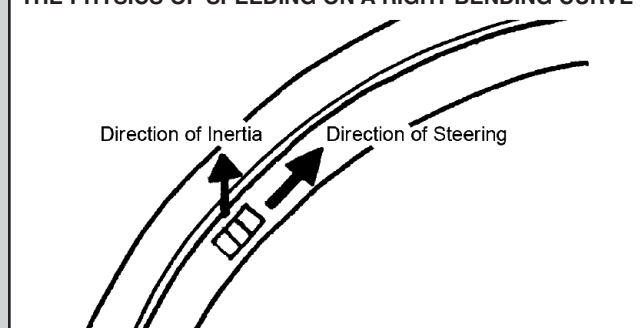

NEGOTIATING HIGHWAYS AND INTERCHANGES

Crashes on highways are the most severe because traffic is moving at a high speed. You are at greatest risk at highway interchanges, when you are changing lanes, and when traffic unexpectedly slows or stops, due to congestion.

ENTERING HIGHWAYS

Your first critical decision when entering a highway is to make sure you do not turn onto the exit ramp by mistake and drive head-on into other traffic. The exit ramp will be marked with **ONE WAY** signs as well as **DO NOT ENTER** and **WRONG WAY** signs. Sometimes, but not always, the entrance ramp will have a green sign that says **HIGHWAY ENTRANCE**. If you see a white line on your right and a yellow line on the left, you are headed in the right direction.

Some highway entrances and exits are very close together with only a short "weaving lane" in between. Traffic entering and exiting the highway must share the weaving lane. A potential threat is posed by two (2) drivers who want to use the same space at the same time. If you are the driver entering the highway, you must yield to the exiting driver. Entrance ramps for highways often have acceleration lanes. These lanes run beside main traffic lanes and should be long enough to allow you to accelerate to the speed of traffic before you enter the highway itself. When looking for a gap while driving on a highway entrance ramp, look over your shoulder and in your side mirror.

EXITING HIGHWAYS

Get in the proper lane for exiting well in advance. Do not slow down until after you have moved into the exit lane. If you miss your exit, take the next one. Do not stop or back up on the highway. Do not swerve across several lanes to try to make the exit at the last second. Do not cross over the median to try to turn around. These maneuvers are illegal and can be extremely hazardous to your health and safety. Exit ramps have a warning sign to let you know the maximum safe speed.

TRAVELING ON HIGHWAYS

Half of the fatal crashes on highways involve vehicles that have run off of the road as the result of speeding and/or driver fatigue - **65 mph is almost 100 feet per second - it takes less than one (1) second to run off of the road.**

When you change lanes to pass a slower moving vehicle on a highway, only change lanes one (1) lane at a time, use your turn signal every time you change lanes, and turn it on in plenty of time for other drivers to see it.

If you see a vehicle about to enter the highway from an on-ramp, a common courtesy is to change lanes to allow the driver to enter the highway more easily. Even though the entering driver is required to yield the right-of-way to you, such a courtesy on your part keeps traffic moving smoothly. But, first check to make sure it is clear around your vehicle.

Another risk when driving on highways is inattention due to "highway hypnosis." This happens when you stare straight ahead at the roadway for long periods of time, and stop actively scanning ahead, behind and around your vehicle. If you "zone out" in this way, you are very likely to crash into traffic slowing or stopping ahead of you. Of fatal crashes on highways, 20 percent involve rear-end collisions. Driver inattention and following too closely account for most of these crashes.

PARKING

If the street you are on has a curb, park as close to it as you can, but no more than 12 inches away. If it has no curb, pull as far off of the roadway as possible.

When you must park on the roadway, use your four-way flashers and give enough room to passing vehicles. Make sure your vehicle can be seen at least 500 feet in both directions.

Always park in the direction traffic moves. Make sure your vehicle cannot move. Set your parking brake and shift to "Park," if your vehicle has an automatic shift or to "Reverse" or "First," if your vehicle has a manual shift. If you are parked on a hill, turn your wheels as shown in the diagram. When parking your vehicle on a downhill with or without a curb, you should turn your steering wheel so your wheels are completely to the right.

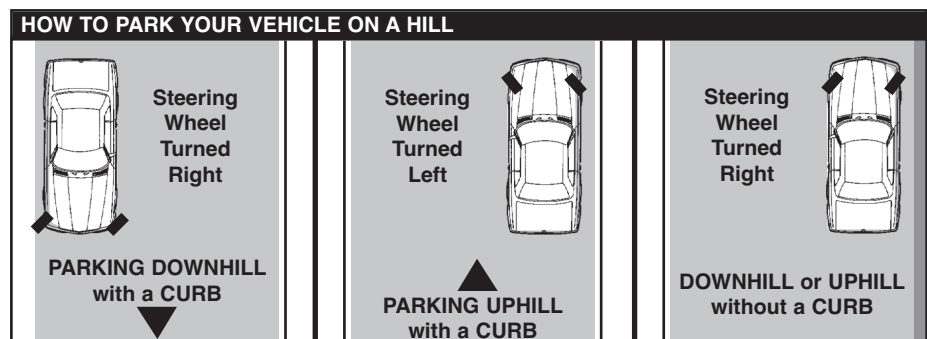

Except in emergencies or unless a police officer tells you to do so, never stop, stand or park your vehicle at the following places:

- On the roadway side of a vehicle already stopped or parked along the edge or curb of the street (double parking).
- On the sidewalk.
- Within an intersection.
- On a crosswalk.
- Along or opposite any street digging or work area.
- On any bridge or other elevated structure, or in a highway tunnel.
- On any railroad tracks.
- Between roadways of a divided highway, including crossovers.
- Within 50 feet of the nearest rail at a railroad crossing.
- At any place where official signs prohibit parking.
- At any place where official signs prohibit stopping.
- In front of a public or private driveway.
- Within 15 feet of a fire hydrant.
- Within 20 feet of a crosswalk at an intersection.
- Within 30 feet of any flashing signal, stop sign, yield sign or traffic control device located at the side of a roadway.
- Within 20 feet of a driveway entrance to a fire station.
- Where your vehicle would prevent a streetcar from moving freely.
- On a limited access highway, unless official traffic control devices indicate you are allowed.

PARALLEL PARKING TIPS

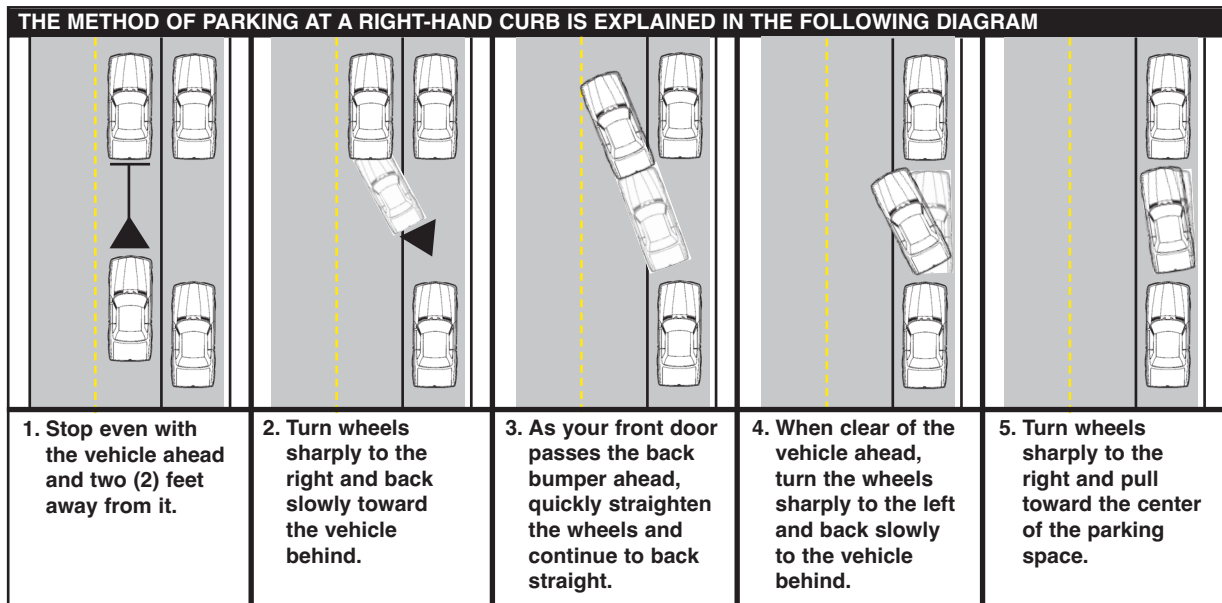

If the street you are on has a curb, you must park as close to it as possible, but no more than 12 inches away. If it has no curb, you must pull as far off of the roadway as possible.

Before leaving your vehicle, turn off the engine, remove the key and lock all doors. Check for traffic behind you before you get out.

Click on the following link to watch our PennDOT Parallel Parking Training Video.

<https://www.youtube.com/watch?v=iZs-q6PmC7E>

SPECIAL CIRCUMSTANCES AND EMERGENCIES

The following pages give you information about how to drive safely and reduce your risk of crashing in these special circumstances – in highway work zones, at railroad crossings, and when you encounter pedestrians, cyclists, trucks, buses or emergency vehicles – and when you must deal with road rage and various driving emergencies.

Information about special events and emergencies is useful for motorists to plan their trip. A motorist may choose to avoid undesirable delays, or even potentially unsafe roadway conditions, by checking media, such as www.511PA.com to see if their trip route is clear before they depart.

WORK ZONES

Work zones are areas with construction, maintenance or utility work activities and are identified with orange channelizing devices, such as cones, or other temporary traffic control devices. You may encounter a flagger directing traffic and wearing reflective clothing. Warning signs, advance warning vehicles, or variable message boards may be placed a minimum of 200 feet approaching a work zone. When you see the first sign, pay strict attention to the road, vehicles, equipment and people you could encounter. Some work zones are accompanied by the Pennsylvania State Police.

Moving operations, such as line painting, crack sealing and mowing sometimes use shadow vehicles at the back of the operation to warn motorists that there is a work zone ahead and also serve as protection to the crew. Do not pass a moving operation unless directed to.

An **active work zone** is where workers are located on or near the roadway. **Always watch out for construction workers** and be prepared for abnormal conditions such as narrow lanes, rough pavement, uneven lanes and abrupt lane shifts.

Drivers must yield the right-of-way to workers and construction vehicles in work zones. By law, you must turn on your vehicle's headlights, not just the daytime running lights, when driving through these areas. You may be fined for failure to use your headlights in an active work zone. Also, fines are doubled for certain violations in active work zones, including speeding. In addition, certain violations will result in a driver's license suspension.

A new video about safely driving in and near work zones is available at:

<https://www.penndot.gov/TravelInPA/Safety/TrafficSafetyAndDriverTopics/WorkZone>.

This video is also available to school based Driver Education courses.

Be prepared for slow or stopped traffic as you approach a work zone, and follow these safety rules:

- Plan your trip. You may avoid travel delays if you choose an alternate route around the work zone.
- Do not use your cruise control in work zones.
- Double your following distance; the most common crash type in work zones is the rear-end collision.
- Prepare to change lanes as soon as you see a message telling you your lane is closed ahead.
- DO NOT CROSS a solid white line in a work zone; stay in your lane.
- Proceed cautiously and keep moving at a safe speed as you drive through the work zone; do not slow or stop to watch roadwork.
- Do not stop within a work zone to ask directions from the workers.
- Obey flaggers – their authority overrides conventional traffic control devices.

Remember: Work Zone Flaggers can report unsafe motorists, speeders, and aggressive drivers to the police using a Police Arrest Form!

DID YOU KNOW?

Every year in the U.S., about 40,000 people, including highway workers and motorists, are injured or killed as a result of vehicle crashes in work zones.

Carelessness and speeding are the main causes of traffic fatalities in work zones.

RAILROAD CROSSINGS

Most railroad crossings are protected only by an advanced warning sign and a crossbuck. Most crossings do not have gates to stop traffic. You must be especially alert when approaching all railroad crossings.

Familiar crossings without much train traffic can be the most dangerous. If you often use such a crossing and do not usually see a train, you may start to believe trains never go by; believing this can be dangerous.

Remember these points at railroad crossings:

- Always look left, right and then left again as you approach a railroad crossing. Do this even if the crossing is active and the signals are not flashing - they may not be working.
- If you are stopped at a railroad crossing with more than one track, do not start as soon as the train passes. Wait until you have a clear view down both tracks before you start across. Even with one (1) track, do not start across immediately after a train passes - check again for another train that may be approaching.
- Never try to pass someone as you approach or enter a railroad crossing.
- Do not blindly follow the lead of another vehicle crossing the tracks. If you are following another vehicle, check to make sure you have enough room to get all the way across before you drive onto the tracks. If traffic slows ahead of you, wait for it to clear before starting to cross. **Do not ever get trapped on the tracks.**
- If you make the mistake of getting trapped on a railroad crossing and a train is approaching, quickly leave the vehicle and move as far away from the track as you can.

DID YOU KNOW?

Every hour and a half, a train collides with a vehicle or a pedestrian in the U.S. You are 40 times more likely to die in a crash involving a train than you are in a crash with another vehicle.

SHARING THE ROAD WITH PEDESTRIANS, BICYCLISTS, AND MOTORCYCLISTS AND MOPED DRIVERS

Pedestrians and cyclists deserve your respect as a vehicle operator. These groups are all more vulnerable to injury in a crash, yet have rights to use the public roads just as you do. Remember the following safety tips.

PEDESTRIANS

- Yield to pedestrians crossing at intersections or in crosswalks.
- Right turn on red means stop, look in all directions, and then turn when it is safe. Look for pedestrians, and allow ample time for them to clear the crosswalk.
- Always reduce speed, and use extra caution when children are in the vicinity. They may fail to understand the danger and may run out in front of you without looking.
- You must observe school zone speed limits and stop for school buses when red signals are flashing. School zones and school bus stops are locations with high concentrations of children.
- Be patient with elderly pedestrians and pedestrians with disabilities. They need extra time to cross a street.
- Before backing up, always check for pedestrians in your path.
- Yield the right-of-way (slow down and prepare to stop) to blind pedestrians, whether they have a white cane or a guide dog, or are being led by others.
- When approaching a stopped vehicle from behind, slow down and do not pass until you are sure there are no pedestrians crossing in front of it.
- When pedestrians do see you, it is never safe to wave a pedestrian into the line of traffic at any time and especially at unmarked or mid-block locations.

BICYCLISTS

Safety Tips (refer to Chapter 5 for more information)

- When approaching or passing a bicycle, slow down to a safe speed.
- After you have passed a bicyclist, do not slow down or stop quickly. A quick stop could lead to the bicyclist crashing into your vehicle.
- Do not sound your horn close to bicyclists, unless you must do so to avoid a crash.

For more information, the Pennsylvania Bicycle Driver's Manual (PUB 380) can be found at:
<http://www.dot.state.pa.us/public/pubsforms/Publications/Pub%20380.pdf>

MOTORCYCLISTS AND MOPED DRIVERS

- According to the law, you must allow the motorcyclist/moped driver to use one (1) complete lane.
- Most motorcycle/vehicle or moped/vehicle crashes happen at intersections. Usually, the vehicle turns left in front of a moving motorcycle/moped when the driver of the vehicle should have yielded the right of way.
- Do not assume a motorcycle/moped is turning when you see its turn signal flashing. A motorcycle/moped's turn signals may not turn off automatically, like a vehicle's. Do not pull out in front of a motorcycle/moped until you see it actually turning.
- Obstacles that may prove minor to a motorist can be deadly to a motorcyclist/moped driver. Be prepared for motorcyclists/moped drivers to make sudden changes in lanes or speed as they attempt to avoid a hazard on the road.
- Allow the same 4-second following distance or more you would allow for other vehicles. Increase your following distance behind a motorcycle/moped, when road or weather conditions are bad.

Click on the following link to watch our PennDOT Motorcycle Safety Video.

<https://www.youtube.com/watch?v=SZjHD9ilz-o>

SHARING THE ROAD WITH TRUCKS AND BUSES

Whether you are sharing the road with a vehicle, truck, bus or other large vehicle, it is important for safety's sake to obey traffic laws, abide by the rules of the road and drive defensively. There are special rules for sharing the road with trucks and buses, and the following are some suggestions you can use to make your trip safer. The key to safer highways is to know the truck's or bus's blind spot (No-Zone). The No-Zone represents danger areas around trucks and buses where crashes are more likely to occur.

PASSING A TRUCK

On a level highway, it takes only three (3) to five (5) seconds longer to pass a truck than a vehicle. On an upgrade, a truck often loses speed, so it is easier to pass than a vehicle. On a downgrade, the truck's momentum will cause it to go faster, so you may need to increase your speed.

When vehicles cut in too soon after passing and then abruptly slow down, truck drivers are forced to compensate with little time or room to spare.

Make sure there is plenty of space between your vehicle and any vehicle ahead of you in the passing lane so you are not trapped, if the truck begins to pull into your lane. Pass quickly without hanging in the truck's blind spot. Keep both hands on the wheel to deal with the effects of turbulence. You may want to stay to the left side of the passing lane. Complete your pass as quickly as possible, and do not stay alongside the other vehicle. Be sure to move back only when you see the front of the truck in your rearview mirror. After you pass a truck, maintain your speed. Think twice about passing on curves where there is a greater danger of error and a higher collision potential.

Fact: Allow yourself plenty of time when passing a truck. At highway speeds, it can take up to 30 seconds to safely pass a truck. When you pass, do so quickly. Do not continuously drive alongside a truck - you are in the truck driver's blind spot. After passing, change lanes only when you can see the truck's headlights or front grill in your rearview mirror.

TRUCK PASSING

When a truck passes your vehicle, you can help the truck driver by keeping to the far side of your lane. You will make it easier for the truck driver if you reduce your speed slightly and then keep your speed steady. In any event, do not increase your speed while the truck is passing you. Trucks have much larger No-Zones on both sides of their vehicle than passenger vehicles. When you drive in these No-Zones, you cannot be seen by truck drivers. If you are in a truck's blind spot and it begins to move over into your lane, remain calm and take note of your vehicle's position relative to the front of the truck. Decide whether to speed up or slow down to avoid a collision. Consider the shoulder as an escape route.

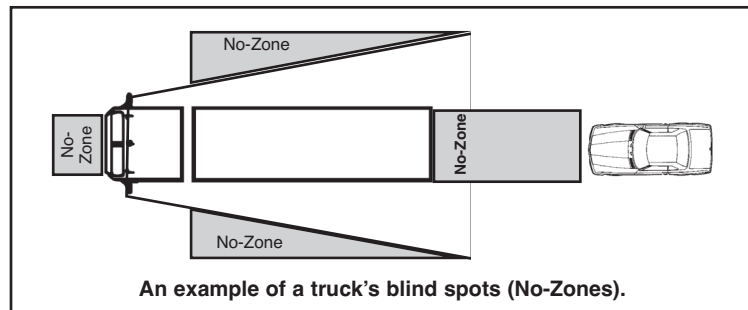

When you meet a truck coming from the opposite direction, keep as far as possible to the side to avoid a sideswipe crash and to reduce the wind turbulence between your vehicle and the truck. Remember, the wind turbulence pushes vehicles apart. It does not pull them together. Maintain plenty of cushion between your vehicle and any vehicle ahead of you.

FOLLOWING A TRUCK

Because of their size, trucks need longer distances to stop. However, a vehicle following too closely still may not be able to stop quickly enough to avoid rear-ending the truck. If you are following a truck, stay out of its No-Zone. Avoid following too closely and position your vehicle so the truck driver can see it in their side mirrors. You will then have a good view of the road ahead, and the truck driver can give you plenty of warning for a stop or a turn. You will have more time to react and make a safe stop. When following a truck or bus, if you cannot see the side mirrors of the vehicle in front of you, the driver of the large vehicle cannot see you.

Leave plenty of room between you and the truck when coming to a stop on a hill. Trucks may roll back as a driver takes their foot off of the brake.

When you follow a truck or any vehicle at night, always dim your headlights. Bright lights from a vehicle behind will blind the truck driver when they reflect off of the truck's large side mirrors.

Fact: At least four (4) seconds are needed to keep you out of the truck's rear blind spot, and here's an easy method to compute the correct distance: As a truck passes a stationary object alongside the road, start counting, one thousand one, one thousand two, etc. You should reach one thousand four just as your front bumper reaches the same object. If you arrive before one thousand four, you are traveling too close to the back of the truck.

URNS

Pay close attention to truck turn signals. Truck drivers must make wide turns so the rear of the truck or the rear of a tractor trailer can clear the corner or any other standing obstructions. Sometimes, space from other lanes is used to clear corners. To avoid a crash, do not pass until the turning action is complete. Again, pay close attention to turn signals. *(Refer to the example below.)*

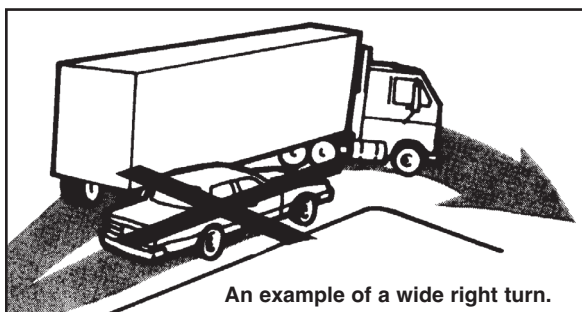

Fact: Trucks make wide turns. It may look like trucks are going straight or turning left when they are actually making a right turn. This technique – combined with blind spots alongside the trailer – makes trying to pass a turning truck a dangerous maneuver. Truck drivers cannot see vehicles squeezing in between them and the curb. Stay put, and give truck drivers plenty of room to turn.

OVERSIZED LOADS

Oversized loads are accompanied by pilot vehicles. Oversized load movements operate the same as tractor trailers and should be treated with the same rules as trucks. Most oversized loads operate within prescribed lanes; however, due to their excessive width, obstacles on the berm could cause them to cross the yellow or white line.

Pilot vehicles are required by law to help warn motorists of oversized loads and/or slow moving vehicles. Pilot vehicles are required to have special signs and lights to help identify them as such, and drivers should be aware that when they are seen they are approaching an oversized vehicle. When you see these vehicles, please take extra caution.

BACKING CRASHES

Never try to cross behind a truck preparing to back up. Often, when a truck driver is preparing to back the truck from a roadway into a loading area, there is no choice but to temporarily block the roadway. It is here that some drivers and pedestrians attempt to pass behind the truck rather than wait the few seconds for the truck to complete its maneuver. In passing close behind the truck, the driver or pedestrian enters the truck's No-Zone, and a crash may occur.

BRAKING

Unlike the hydraulic brakes on vehicles, trucks and buses may have air brakes and take longer distances to stop. A loaded truck with good tires and properly adjusted brakes, traveling at 65 mph on a clear, dry roadway, requires a minimum of 600 feet to come to a complete stop (compared to the stopping distance of 400 feet for a passenger vehicle). It is essential to refrain from entering a roadway and if you are turning off of the roadway, to avoid changing lanes in front of a large vehicle.

ESCAPE RAMPS

On long downgrades, there may be special "escape" or "runaway" ramps for trucks. These ramps are to be used only by large vehicles that are out of control or cannot stop because of brake failure. Never stop or park in the vicinity of these ramps.

BUSES

Buses are vehicles that also take up more room on a road than an ordinary vehicle. The same procedures should be followed when sharing the road with a bus or truck.

SCHOOL BUSES

Pennsylvania has special rules you must follow when you drive near a school bus. These rules protect children and drivers.

When a school bus is preparing to stop, its amber (yellow) lights will begin flashing. When the bus stops with its red lights flashing and its stop arm extended, you must stop at least 10 feet away from the bus whether you are behind it or coming toward it on the same roadway or approaching an intersection at which the school bus is stopped. Remain stopped until the red lights stop flashing, the stop arm has been withdrawn, and the children have reached a safe place (see picture below).

**ALL VEHICLES
MUST STOP!**

Failure to stop for a school bus with a flashing red light and extended stop arm will result in a 60-day suspension of your driver's license, five (5) points on your driving record and a fine.

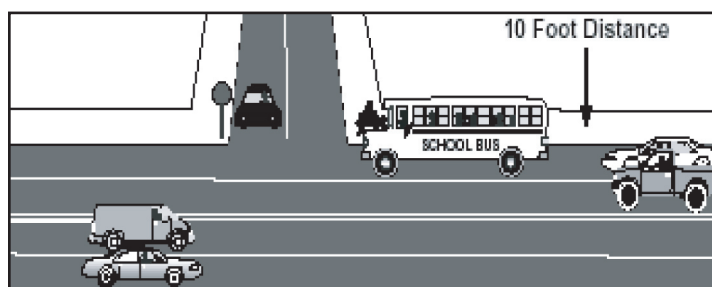

There is only one exception to the school bus stopping requirement. If you are approaching a school bus that is stopped with its red lights flashing and stop arm extended and you are driving on the opposite side of a divided highway, (i.e. concrete/metal barriers, guide rails or trees/rocks/streams/grass median), you do not have to stop. Reduce your speed and continue driving with caution.

Check out this graphic that helps illustrate Pennsylvania's school bus stopping law.

<https://www.penndot.gov/TravellnPA/Safety/TrafficSafetyAndDriverTopics/Pages/School-Bus-Safety.aspx>

EMERGENCY VEHICLES AND SITUATIONS

Certain vehicles have sirens and flashing red lights or a combination of flashing red and blue lights. The lights assist emergency vehicles to move quickly through traffic and to answer emergency calls. Emergency vehicles include fire department vehicles, police cars, ambulances, blood delivery vehicles and specially equipped vehicles from rescue organizations. Watch out for them.

When you hear a siren or see a vehicle approaching from any direction with flashing red lights or a combination of red and blue lights, you must:

- Pull over to the curb or side of the road and stop.
- Drive parallel and as near to the curb as possible. On one-way streets, drive toward the nearest roadside and stop.
- Stay clear of intersections.
- Start driving again after the emergency vehicle passes you, keeping at least 500 feet away from it.
- Make sure another emergency vehicle is not coming.

During an emergency situation, all drivers must obey the direction of any uniformed police officer, sheriff, constable or any properly attired person, including fire police.

Take sirens seriously, and make way for an ambulance, fire truck or police vehicle. Someday you may be the one calling for help, or the life on the line might be a friend or family member.

MOVE OVER LAW

The Move Over law, requires motorists to move into a lane that is not adjacent to an emergency response area and or disabled vehicle. An emergency response area is an area on or near a road where services are being provided by police, sheriffs, coroners, medical examiners, firefighters, fire police, fire marshals, rescue personnel, emergency medical service personnel, towing and recovery personnel, hazardous material response team members and/or highway construction and maintenance personnel. A disabled vehicle is a vehicle in a traffic lane or on the side of a traffic lane that is clearly marked with at least two signal lamps, road flares, caution signs and/or any other traffic control device. If drivers cannot move over because of traffic or other conditions, they must reduce their speed to at least 20 miles per hour below the posted speed limit. In cases where law enforcement may not be present, the law allows road workers and emergency responders to report violations by motorists. Law enforcement may issue citations based on these reports. Failure to move over or slow down can result in a summary offense that carries a fine of up to \$500 for a first offense, \$1,000 for a second offense and \$2,000 for a third and subsequent offense. In addition, fines will be doubled for traffic violations occurring in work zone areas. Any person convicted of a violation of this law will have 2 points assessed to their driving record. If the violation of this law leads to the serious bodily injury or to death of another person, a 90-day license suspension will be imposed and a fine of up to \$1,000 could result. If the violation of this law leads to the serious bodily injury of an emergency responder or a person in or near a disabled vehicle, a 6-month license suspension will be imposed and a fine of up to \$5,000 could result. If the violation of this law leads to the death of an emergency responder or a person in or near a disabled vehicle, a 1-year suspension will be imposed and a fine of up to \$10,000 could result.

HORSE-DRAWN VEHICLES AND HORSEBACK RIDERS

There are some important things to keep in mind in areas where you may encounter horse-drawn vehicles or horseback riders. Many horse-drawn vehicles are dark in color and therefore are difficult to see at dawn, dusk or night. When following or stopped behind a horse-drawn vehicle, be sure to leave plenty of room between the two (2) vehicles. After stopping, horse-drawn vehicles often roll backward, and following too close limits the horse-drawn vehicle driver's ability to see you. This will also provide adequate space for when you prepare to pass. When you pass a horse-drawn vehicle or horseback rider, do not drive too fast or blow your horn, as this may spook the horse. Also, to avoid spooking the horse after passing, be sure to leave enough space between your vehicle and the horse before pulling back into the right lane. Always remember, when on the road everyone has the same rights.

PASSENGERS IN AN OPEN-BED TRUCK

An open-bed pickup truck or open flatbed truck may not be driven at a speed of more than 35 mph, if any person is occupying the bed of the truck. Such a truck may not be driven when a child under 18 years of age is occupying the bed of the truck.

Exceptions to this law are:

- A child of a farmer, who is being transported between parts of a farm or farms owned or operated by the farmer in order to perform work on the farm or farms.

- A child employed to perform farm labor, who is being transported between parts of a farm or farms owned or operated by the child's employer or employers.
- A child possessing a valid hunting license, who is being transported between a hunting camp and a hunting site or between hunting sites during hunting season.
- A child, who is a participant in an officially sanctioned parade, only during the course of the parade.

SNOW PLOWS

Plow drivers removing snow in the winter have very limited visibility in their mirrors. Plows must often turn around, and their drivers cannot see you behind them. Be sure to follow at a safe distance. This will help protect your vehicle from being damaged by the salt, de-icing liquids and anti-skid pellets thrown from snow plows.

Also, these vehicles may have wing plows that stick out several feet on either side. These are difficult for drivers to see in bad weather or at night and have been involved in multiple side-swipe accidents. To be safe, you should not attempt to pass a plow, either on the left or on the right.

DEALING WITH ROAD RAGE

NEVER take your anger out on someone else on the road. Sometimes incidents of road rage are caused by simple misunderstandings between drivers. One driver may make a momentary error in judgment that another driver sees as an aggressive act, though none was intended.

NEVER take it personally when someone cuts you off or pulls in front of you. Just let it go, and ignore the other driver.

If something does happen, **DO NOT RETALIATE**. It is a serious distraction to focus your attention on a "contest" with another driver. You are less able to respond to traffic signs, signals and the actions of other vehicles or pedestrians, as needed to avoid a crash.

DO NOT TRY TO TEACH ANOTHER DRIVER A LESSON. Do not insist on being right, even if you are right. You could be dead right!

Here are some tips to help you stay safe, if you encounter an aggressive driver:

- Make every attempt to get out of the aggressive driver's way.
- Do not block the passing lane. If someone demands to pass, let them go.
- Do not challenge an aggressive driver by speeding up. It will just make the driver angrier and endanger you.
- Avoid eye contact with a hostile driver.
- Ignore gestures, and do not gesture back.
- Call the police or 911, if you have a hands free device and can do it safely, or have a passenger call.

If an aggressive driver pursues you, do not go home. Instead, drive to a police station, convenience store or other location where you can get help and there will be witnesses.

DEALING WITH DRIVING EMERGENCIES

If you are like most drivers, you will not have the chance to practice how you would act in an emergency before it happens. But, knowing what to do in certain critical driving situations can still make a difference. Taking the wrong action or no action when something goes wrong obviously will increase your chances of crashing your vehicle.

STEERING YOUR WAY OUT OF AN EMERGENCY

When you have a choice of either braking or steering to avoid a collision, it is usually better if you can steer to avoid the hazard than to brake, particularly at speeds above 25 mph. This is because your reaction time to swerve is

DID YOU KNOW?

Of the approximate 1,500 highway deaths in PA each year, about 60 percent, or around 900, are attributed to aggressive driving.

DID YOU KNOW?

In a review of 12,000 crashes, 37 percent of the drivers took no action to avoid the crash.

faster than your reaction time to brake. But, you must have good steering skills to keep control of your vehicle in an emergency.

As a general rule, you should be holding the steering wheel with both hands. This is especially important in emergencies because evasive steering requires you to turn the steering wheel quickly at least one-half turn in one (1) direction, and then turn the wheel back almost a full circle in the opposite direction, once you clear the object. You then return to center steering to continue moving in your original direction of travel. At higher speeds, less steering input is needed to move your vehicle to the left or right.

Get into the habit of holding the steering wheel as shown at right. If you think of the steering wheel as a clock face, your hands should hold the wheel at either the 9 and 3 o'clock position or the 8 and 4 o'clock position, whichever is the most comfortable. Keep your thumbs along the face of the steering wheel instead of gripping the inside of the rim.

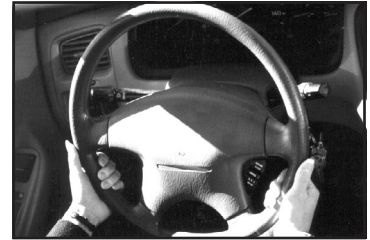

By keeping your hands in this position on the wheel:

- You will be less likely to overcorrect during an emergency steering maneuver, which could cause you to spin out of control or run off of the road.
- It is less likely the air bag will throw your arms and hands back into your face, maybe even breaking them, if you are involved in a crash.
- Your arms will be more comfortable and less fatigued during long drives.

A ten (10) and two (2) o'clock hand position is acceptable; however, if your air bag deploys, you are at risk of injury. There are two (2) ways to use the steering wheel to make a turn. In the "hand-over-hand" method, the driver reaches across the steering wheel to grasp the opposite side and pulls the wheel over the top, repeating as needed. In the "push-pull" method, one (1) hand pushes up on the steering wheel while the other hand slides to the top and then pulls the wheel down, repeating the action until the turn is complete.

If you cannot avoid a collision, remember this: Injury prevention in a crash depends mostly on wearing your seat belt properly, having your head restraints properly adjusted, having an air bag in your vehicle and being positioned at least ten (10) inches away from your air bag.

IF YOU HAVE TO BRAKE SUDDENLY

If you need to hit your brakes in a hurry, your safety depends on knowing whether your vehicle has conventional or anti-lock brakes (ABS), and how to use them.

- **Without ABS**, press and release the brakes repeatedly. Pumping the brakes will slow your vehicle and keep it under control. Slamming on the brakes can lock your wheels, causing your vehicle to skid.
- **With ABS**, maintain firm and continuous pressure on the brake - your vehicle will not skid. **Do not pump the brake pedal.** Do not be alarmed by mechanical noises and/or slight pulsations.

You should check your owner's manual to determine what kind of braking system your vehicle has. Do this before you get into an emergency. **Knowing how to apply your brakes in an emergency situation may save your life.**

IF YOUR VEHICLE STARTS TO SKID

If your vehicle starts to skid on a wet or icy road, look and steer in the direction you want to go. If the rear of your vehicle is skidding to the left, turn the wheel to the left. If the rear of your vehicle is skidding to the right, turn the wheel to the right. When you steer to correct a skid, another skid may result in the opposite direction, but the second skid will not be as bad as the first. Be ready to stop the second skid the same way - by steering in the direction the rear of your vehicle is skidding. It may take a few of these "corrections" before you have fully regained control of your vehicle.

When skidding, do not use your brakes. If you hit the brakes, the skid will be worse. You risk locking your wheels and losing all steering control.

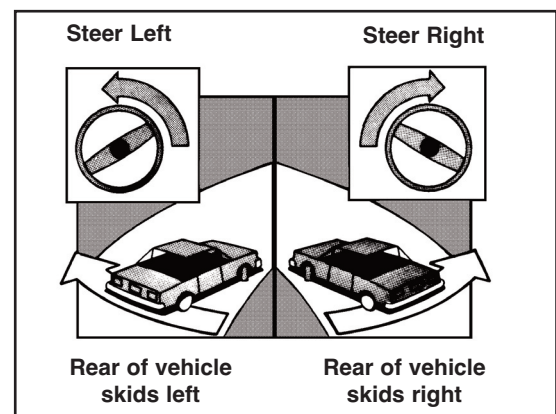

FLOODED ROADWAYS

On flooded roadways, even at low speeds, as little as six (6) inches of water can cause you to lose control of your vehicle or truck and can float some small vehicles. Two (2) feet of water will carry away most vehicles, including sport utility vehicles (SUVs). Once a vehicle floats off of the roadway into deeper water, it may roll and fill with water, trapping the driver and passengers inside. **If there is moving water on the road, the safest thing to do is find another route.**

NOTE: It is against the law to drive around or through signs or traffic control devices that close a road or highway due to hazardous conditions. For more information on the law and its penalties see Chapter 5.

FLOODS:

Flooding is one of Pennsylvania's top hazards. According to the Centers for Disease Control and Prevention, since 2006 nearly half of all flooding deaths reported in Pennsylvania were related to vehicles. If you are driving and you reach a flooded roadway, remember this simple phrase: "Turn Around, Don't Drown®". Find another travel route and do not attempt to cross any flooded roadway. It is against the law to pass any flood control barrier. This list shows several reasons why floodwaters are so dangerous:



- Six inches of water, the length of a dollar bill, can cause some cars to lose control or stall.
- Twelve inches of moving water can float many cars.
- Two feet of moving water can move most SUV's and pick-up trucks.
- Water over any roadway can hide many hazards, including missing pavement and bridges. Moving water can also weaken the roadway.
- Night travel may hide flooded roadways.

Your best option when you reach a flooding roadway is to find a new route to your destination. If you do get stuck in floodwaters, quickly get out of your vehicle and move to higher ground. More information on flooding from the National Weather Service can be found online: www.weather.gov/safety/flood-turn-around-dont-drown

IF YOUR ACCELERATOR STICKS

If the accelerator (gas pedal) sticks, your vehicle may keep going faster and faster.

If this happens:

1. Keep your eyes on the road. You can tap the pedal a few times to see if it will spring back to normal, or you may be able to lift it with your toe, but do not reach down to try to free the pedal with your hand.
2. Shift to neutral immediately and use the brakes, if the pedal remains stuck. This will cause your engine to race, but the power will be removed from your wheels.
3. Concentrate on steering and pull off of the road when you have slowed down to a safe speed. Stop, turn off the engine, and put on your emergency flashers.

NOTE: If you need to slow or stop quickly, turn your ignition to "OFF." Do not turn it to "LOCK" because you will lose steering ability. Then, apply your brakes. It will require more effort to steer and brake with your ignition off.

IF YOUR VEHICLE HAS BRAKE FAILURE

In newer vehicles, a split braking system reduces the possibility of total brake failure. If your brake system warning light comes on, you may have braking in two (2) of the four (4) wheels, probably one (1) front wheel and one (1) rear wheel. This will allow you to pull over to the side of the road or into the next service station. You will feel the brake pedal go down farther than usual before the vehicle begins to slow, and you will need to push harder on the pedal. Your stopping distance is increased, so be aware of where your vehicle is headed. Shifting to a lower gear will help you slow down.

IF YOU HAVE AN OLDER VEHICLE AND YOUR BRAKES SUDDENLY FAIL, YOU SHOULD

1. Shift to low gear and look for a place to slow to a stop.
2. Pump the brake pedal quickly several times. This will often build up enough brake pressure to stop the vehicle.
3. Use the parking (emergency) brake if pumping the brake pedal does not work. Hold the brake release so you can let off of the parking brake, if the rear wheels lock, and you begin to skid.
4. Keep your eyes focused on where you are going, and look for a safe place to pull off of the road. Look for an open place to steer into, or steer into an uphill road.
5. Turn your ignition "OFF" as a last resort, if the vehicle still will not stop and you are in danger of crashing. Do not turn it to the "LOCK" position because this will also lock your steering. Then, shift into your lowest gear. This could damage your transmission, so only do this as a last-ditch effort to keep you from crashing.

After you have stopped your vehicle, call for help. Do not try to drive.

IF YOU HAVE A TIRE BLOWOUT

Sometimes thumping noises start before a tire blows out, but you usually will not know ahead of time when a tire will blow. You should protect against blowouts by keeping your tires in good condition and properly inflated.

When a front tire blows out, your steering wheel will vibrate, and you will feel the vehicle suddenly pull to one side. When a rear tire blows out, one corner of the vehicle will drop suddenly, and you will feel the rear of the vehicle wobble back and forth.

If one of your tires blows out, do the following:

1. Hold the steering wheel tightly.
2. Stay off of your brake! Braking after a blowout will cause you to skid and lose control of your vehicle.
3. Slowly take your foot off of the gas pedal.
4. Steer where you want to go, but steer smoothly - do not make large or jerky steering actions.

You can ride on a flat tire as long as you need to, in order to get to a safe spot to pull over and change it. If you have to use your brakes, press them gently. Let the vehicle slow to a stop. Make sure it is off of the road before you change the tire.

HOW TO CHANGE A FLAT TIRE

Keep the tools you will need to change your tire in your vehicle at all times, i.e., spare tire, lug wrench, jack, screwdriver, flashlight, flares and reflective triangles, wheel wedges, flat tire repair kit, gloves, etc.

Basic instructions for changing a tire. **NOTE:** The process may differ from vehicle to vehicle, so please consult the vehicle owner's manual.

1. Park the vehicle on a flat surface that is away from traffic and as far off of the road as possible.
2. Apply the parking brake and secure the vehicle by placing bricks, wooden wedges, or wheel chocks at both the front and rear of any one of the remaining good tires.
3. If the vehicle has a wheel cover or a hubcap, carefully pry it off by using a screwdriver or the flat end of the lug wrench.
4. While the vehicle is on the ground, loosen the lug nuts by using the end of lug wrench that fits the lug nuts of the vehicle. During this step, do not fully remove the lug nuts from the lug bolts.
5. Place the jack on solid ground securely under the frame or suspension of the vehicle, and/or by consulting the vehicle owner's manual for proper placement of the jack. Raise the vehicle with the jack until the tire is approximately 6 inches off the ground.
6. Completely remove the lug nuts and place them in a safe area (inside the wheel cover or hub cap works well). Remove the defective tire by grasping it with both hands and pull it straight and evenly off of the lug bolts.
7. Install the spare wheel/tire onto the wheel lug bolts and install all of the lug nuts by hand. After the nuts are correctly threaded on the lugs, the lug wrench may be used to tighten the nuts; but only use minimal pressure (do not fully torque the nuts at this time).
8. Slowly lower the vehicle on to the ground, but do not remove the jack from under the vehicle at this step.
9. After referring to the vehicle operator's manual for the proper torque sequence and torque specs, tighten the lug nuts using the lug wrench.
10. Secure the jack, tire/wheel, tools, and safety equipment in the trunk of the vehicle.

If the vehicle has wheel covers or hub caps, the owner's manual should provide the instructions for installation. If the vehicle has center caps, place the center cap against the wheel and evenly tap it into place by using the heel of the hand. Verify the securement of the wheel cover or center cap before driving off.

IF YOUR VEHICLE DRIFTS OFF OF THE PAVEMENT ONTO THE SHOULDER

A serious crash can result, if you do not know how to recover steering control after experiencing a “drop-off” along the edge of the road where the shoulder is lower than the pavement. A “drop-off” can happen, if you are driving too close to the edge of the road or if you drive too fast through a curve and allow your front tire to drift off of the road.

“Drop-offs” are fairly common, especially on rural roads. They can also occur where roads are being resurfaced, and there is a ledge at the shoulder.

A “drop-off” can quickly become an emergency, if you do not know how to recover from it. The most important things to remember are: do not steer sharply, and do not brake suddenly. If you turn the wheel sharply to get back onto the road, it can cause the vehicle to whip sideways and cross into oncoming traffic. If you brake hard with two (2) wheels on the pavement and two (2) wheels on a soft shoulder, the vehicle will probably skid out of control.

HERE IS WHAT YOU SHOULD DO IF YOU DRIFT OFF OF THE PAVEMENT

- | | |
|--|---|
| <ol style="list-style-type: none"> 1. Ease off of the gas pedal to slow down when your two wheels on the right side both go off of the pavement. Do not brake suddenly. If you must brake to avoid a hazard on the shoulder, use gradual, controlled braking to avoid locking the wheels. 2. Keep a tight grip on the steering wheel, and steer parallel to the roadway with two (2) wheels on the roadway and two (2) wheels off (straddling the drop off edge). Keep the tires from scraping the edge of the pavement. Stay calm and keep a firm grip on the steering wheel. A soft or wet shoulder will pull your vehicle to the right. Do not steer sharply, trying to get back on the road. | <ol style="list-style-type: none"> 3. Continue to slow gradually until you are traveling very slowly - less than 25 mph and preferably closer to 10 mph - and you have your vehicle under control. 4. Check for traffic approaching from the rear in the lane you will reenter. Turn on your left turn signal. 5. Gently steer left to ease the right wheels onto the pavement, when it is clear. As soon as you feel your wheels come back onto the road, gently steer right to straighten out. 6. Speed up to match the flow of traffic once you are safely back on the pavement and in complete control of your vehicle. |
|--|---|

IF ANOTHER VEHICLE IS APPROACHING HEAD-ON IN YOUR LANE

First, honk your horn to attract attention. If the other driver does not move over, try to escape to the right, if possible. If you swerve left and the other driver corrects at the last instant, you will still crash. If a collision is unavoidable, brake firmly and steadily. Every mile per hour you slow down will reduce the impact.

FUNERAL PROCESSION

If you see a funeral procession on the road, yield to vehicles in the procession. Once the lead vehicle has cleared an intersection, the rest of the procession may proceed through the intersection, other traffic must yield. Allow the procession to pass, and do not cut in and out of the procession, unless you are directed otherwise by a police officer or an agent or employee of the funeral director during a funeral.

All vehicles in a funeral procession must have their headlights and emergency flashers turned on and bear a flag or other insignia designating them as part of the procession. Vehicles in a funeral procession may also have a flashing or revolving purple light displayed on the vehicle during the procession.

Drivers in funeral processions may proceed through a red light or stop sign, if the lead vehicle starts through the intersection while the light was green. In the case of a stop sign, the lead vehicle must first come to a complete stop before proceeding through the intersection. Funeral processions must yield to emergency vehicles.

CHAPTER 3 REVIEW QUESTIONS

- 1. TEENAGE DRIVERS ARE MORE LIKELY TO BE INVOLVED IN A CRASH WHEN:**
 - A. They are driving with their pet as a passenger
 - B. They are driving with adult passengers
 - C. They are driving with teenage passengers
 - D. They are driving without any passengers

- 2. DRIVERS WHO EAT AND DRINK WHILE DRIVING:**
 - A. Have no driving errors
 - B. Have trouble driving slow
 - C. Are better drivers because they are not hungry
 - D. Have trouble controlling their vehicles

- 3. PREPARING TO SMOKE AND SMOKING WHILE DRIVING:**
 - A. Do not affect driving abilities
 - B. Help maintain driver alertness
 - C. Are distracting activities
 - D. Are not distracting activities

- 4. THE TOP MAJOR CRASH TYPE FOR 16 YEAR OLD DRIVERS IN PENNSYLVANIA IS:**
 - A. Single vehicle/run-off-the-road
 - B. Being sideswiped on an interstate
 - C. Driving in reverse on a side street
 - D. Driving on the shoulder of a highway

- 5. WHEN PASSING A BICYCLIST, YOU SHOULD:**
 - A. Blast your horn to alert the bicyclist
 - B. Move as far left as possible
 - C. Remain in the center of the lane
 - D. Put on your four-way flashers

- 6. WHEN YOU DRIVE THROUGH AN AREA WHERE CHILDREN ARE PLAYING, YOU SHOULD EXPECT THEM:**
 - A. To know when it is safe to cross
 - B. To stop at the curb before crossing the street
 - C. To run out in front of you without looking
 - D. Not to cross unless they are with an adult

- 7. IF YOU ARE DRIVING BEHIND A MOTORCYCLE, YOU MUST:**
 - A. Allow the motorcycle to use a complete lane
 - B. Drive on the shoulder beside the motorcycle
 - C. Allow the motorcycle to use only half a lane
 - D. Pass in the same lane where the motorcycle is driving

- 8. WHEN TRAVELING BEHIND A MOTORCYCLE:**
 - A. Allow a following distance of at least 2 car lengths
 - B. Allow at least 2 seconds of following distance
 - C. Allow at least 4 seconds of following distance
 - D. Allow a following distance of at least 4 motorcycle lengths

-
- 9. YOU NEED TO USE EXTRA CAUTION WHEN DRIVING NEAR A PEDESTRIAN USING A WHITE CANE BECAUSE:**
- A. They are deaf
 - B. They have a mental disability
 - C. They are blind
 - D. They have a walking problem
-
- 10. WHEN DRIVING NEAR A BLIND PEDESTRIAN WHO IS CARRYING A WHITE CANE OR USING A GUIDE DOG, YOU SHOULD:**
- A. Slow down and be prepared to stop
 - B. Take the right-of-way
 - C. Proceed normally
 - D. Drive away quickly
-
- 11. WHO MUST YIELD WHEN A DRIVER IS TURNING AND A PEDESTRIAN IS CROSSING WITHOUT A TRAFFIC LIGHT?**
- A. Whoever started last
 - B. The driver
 - C. Whoever is slower
 - D. The pedestrian
-
- 12. AN ORANGE TRIANGLE ON THE BACK OF A VEHICLE INDICATES THAT VEHICLE:**
- A. Carries radioactive materials
 - B. Takes wide turns
 - C. Travels at slower speeds than normal traffic
 - D. Makes frequent stops
-
- 13. AT NIGHT, IT IS HARDEST TO SEE:**
- A. Road signs
 - B. Pedestrians
 - C. Other motorists
 - D. Street lights
-
- 14. WHEN A TRUCK DRIVER BEHIND YOU WANTS TO PASS YOUR VEHICLE, YOUR SPEED SHOULD:**
- A. Remain steady or decrease
 - B. Change lanes
 - C. Change
 - D. Increase
-
- 15. WHEN SHARING THE ROAD WITH A TRUCK, IT IS IMPORTANT TO REMEMBER THAT, IN GENERAL, TRUCKS:**
- A. Take longer distances than cars to stop
 - B. Require less time to pass on a downgrade than cars
 - C. Require less turning radius than cars
 - D. Require less time to pass on an incline than cars
-
- 16. IF YOU STOP AT A RAILROAD CROSSING WITH MORE THAN ONE TRACK:**
- A. Wait until you have a clear view of both tracks
 - B. Stop on the railroad track and watch for another train
 - C. Go through as soon as the train passes
 - D. Go through when one of the tracks is free
-

17. IF YOU ARE FOLLOWING A TRUCK THAT SWINGS LEFT BEFORE MAKING A RIGHT TURN AT AN INTERSECTION, YOU SHOULD REMEMBER THAT IT IS VERY DANGEROUS TO:

- A. Try to squeeze between the truck and curb to make a right turn
- B. Apply your brakes until the truck has completed the turn
- C. Violate the "4 – second" following distance rule
- D. Honk your horn at the truck driver

18. THE ONLY TIME YOU DO NOT HAVE TO STOP FOR A SCHOOL BUS WHOSE RED LIGHTS ARE FLASHING AND STOP ARM IS EXTENDED IS WHEN YOU:

- A. Are driving on the opposite side of a divided highway
- B. Are behind the bus
- C. See no children present
- D. Can safely pass on the left

19. WHEN A SCHOOL BUS HAS ITS LIGHTS FLASHING AND ITS STOP ARM EXTENDED, YOU MUST:

- A. Stop at least 10 feet away from the bus
- B. Pass if children have exited the bus
- C. Stop if the bus is on the opposite side of a barrier
- D. Drive slowly by the bus

20. AFTER A TRAIN HAS PASSED, YOU SHOULD:

- A. Check again for approaching trains and proceed with caution
- B. Wait for a green light
- C. Proceed across the tracks
- D. Blow horn and proceed

21. IF YOU NEED TO SLOW DOWN OR STOP WHEN OTHER DRIVERS MAY NOT EXPECT IT, YOU SHOULD:

- A. Quickly tap your brake pedal a few times
- B. Use your emergency brake
- C. Look over your shoulder for traffic in your blind spot
- D. Get ready to blow your horn

22. WHEN YOU ARE PLANNING TO MAKE A TURN, YOU SHOULD ACTIVATE YOUR TURN SIGNALS:

- A. Only if there are other drivers following you
- B. Just as the front of your car reaches the intersection
- C. 3 to 4 seconds before you reach the intersection
- D. 2 car lengths before reaching the intersection

23. BEFORE PASSING ANOTHER VEHICLE YOU SHOULD:

- A. Flash your headlights to alert the driver
- B. Turn on your four-way flashers to warn the driver
- C. Give the proper turn signal to show you are changing lanes
- D. Sound your horn to get the drivers attention

24. YOUR BLIND SPOT IS THE AREA OF THE ROAD:

- A. You cannot see without moving your head
- B. Directly behind your vehicle
- C. You see in your rearview mirror
- D. You see in your side mirror

25. BEFORE PASSING ANOTHER VEHICLE, YOU SHOULD SIGNAL:

- A. Just before changing lanes
- B. At any time
- C. After changing lanes
- D. Early enough so others know your plans

26. BEFORE CHANGING LANES ON A MULTI-LANE HIGHWAY YOU SHOULD:

- A. Sound your horn
- B. Turn on your headlights
- C. Reduce your speed
- D. Check your mirrors and blind spots

27. WHEN YOU PARK ON THE ROADWAY, YOU SHOULD:

- A. Use your four-way flashers
- B. Park at an angle
- C. Keep your turn signal on
- D. Turn your lights on

28. BEFORE BACKING UP, YOU SHOULD:

- A. Rely on your mirrors to see if it is clear to proceed
- B. Flash your lights
- C. Open your door to see if it is clear to proceed
- D. Turn your head and look through the rear window

29. TO HELP AVOID CRASHES, YOU SHOULD:

- A. Communicate with other drivers on the road
- B. Ignore other drivers on the road
- C. Drive on side streets and back roads
- D. Avoid driving during rush hour

30. THE DRIVER IS:

- A. Slowing or stopping
- B. Turning left
- C. Turning right
- D. Opening their door



31. IF YOUR TURN SIGNALS FAIL, YOU SHOULD USE _____ TO INDICATE YOU ARE TURNING.

- A. Your horn
- B. Your headlights
- C. Hand signals
- D. Your emergency flashers

32. WHEN TRAVELING BELOW 40 MILES PER HOUR ON A LIMITED ACCESS HIGHWAY, YOU SHOULD:

- A. Drive on the shoulder
- B. Use your high beams
- C. Sound your horn to warn others
- D. Use your four-way flashers

33. YOU SHOULD HONK YOUR HORN WHEN YOU:

- A. Are travelling through an intersection
- B. Are passing a bicyclist
- C. See a child who is about to run into the street
- D. Are parallel parking

34. YOU MUST USE YOUR HEADLIGHTS WHEN OTHER VEHICLES ARE NOT VISIBLE FROM _____ FEET AWAY.

- A. 1000
- B. 1500
- C. 1800
- D. 1200

35. IF A VEHICLE USING HIGH BEAMS COMES TOWARD YOU, YOU SHOULD:

- A. Turn on your high beams
- B. Turn off your headlights
- C. Sound your horn
- D. Flash your high beams

36. IF A VEHICLE USING HIGH BEAMS COMES TOWARD YOU, YOU SHOULD LOOK TOWARDS _____ OF THE ROAD.

- A. Either side
- B. The center
- C. The right side
- D. The left side

37. YOU MAY HONK YOUR HORN WHEN YOU:

- A. Have to stop quickly
- B. Are passing another car
- C. Have lost control of your car
- D. Are passing a bicyclist

38. YOUR BRAKE LIGHTS TELL OTHER DRIVERS THAT YOU:

- A. Are making a turn
- B. Have your emergency brake on
- C. Are changing lanes
- D. Are slowing down or stopping

39. BEFORE TURNING, YOU SHOULD:

- A. Use your signal
- B. Turn the wheel
- C. Increase your speed
- D. Change lanes

40. THE DRIVER IS:

- A. Turning left
- B. Slowing
- C. Stopping
- D. Turning right



41. THE DRIVER IS:

- A. Turning left
- B. Stopping
- C. Slowing
- D. Turning right



42. IF ANOTHER CAR IS IN DANGER OF HITTING YOU, YOU SHOULD:

- A. Sound your horn
 - B. Wave your arms
 - C. Use your emergency lights
 - D. Flash your headlights
-

43. IF YOU BEGIN TO FEEL TIRED WHILE DRIVING, THE BEST THING TO DO IS:

- A. Get some coffee
- B. Open your window
- C. Stop driving
- D. Turn on the radio

44. THE EFFECT THAT LACK OF SLEEP HAS ON YOUR SAFE DRIVING ABILITY IS THE SAME AS:

- A. The effect that alcohol has
- B. The effect that amphetamines have
- C. The effect that anger has
- D. The effect that driving with teenagers has

45. TEENAGERS SHOULD TRY TO GET AT LEAST ____ OF SLEEP EACH NIGHT TO AVOID THE RISK OF DROWSY DRIVING CRASHES.

- A. 7 hours
- B. 6 hours
- C. 8 hours
- D. 9 hours

46. IF ANOTHER DRIVER CUTS YOU OFF IN TRAFFIC, YOU SHOULD:

- A. Pull next to the driver and yell at him or her
- B. Ignore the other driver
- C. Flash your high beams at the driver
- D. Get back at the other driver by cutting him or her off

47. IF SOMEONE IS DRIVING AGGRESSIVELY BEHIND YOU, YOU SHOULD:

- A. Try to get out of the aggressive driver's way
- B. Stare at the driver as they are passing you
- C. Speed up as they are passing you
- D. Block the passing lane

48. FOR AN AVERAGE PERSON, HOW MANY MINUTES DOES THE BODY NEED TO PROCESS THE ALCOHOL IN ONE DRINK?

- A. 15
- B. 60
- C. 90
- D. 30

49. _____ LIMIT(S) YOUR CONCENTRATION, PERCEPTION, JUDGMENT, AND MEMORY.

- A. Only a blood alcohol level greater than the legal limit
- B. Alcohol does not
- C. Even the smallest amount of alcohol
- D. Only a blood alcohol level greater than .05

50. TAKING DRUGS ALONG WITH ALCOHOL:

- A. Increases the risk of causing a crash
- B. Is no more dangerous than alcohol by itself
- C. Lessens the effect of alcohol on your ability to drive
- D. Has no effect on your general driving ability

51. AS ALCOHOL BUILDS UP IN YOUR BLOOD, IT:

- A. Slows down your reactions
- B. Makes you feel less confident
- C. Begins to metabolize itself more quickly
- D. Decreases your driving errors

52. IF YOUR BLOOD ALCOHOL LEVEL IS .04, YOU:

- A. Are 2 – 7 times more likely to have a crash than a person who has not consumed any
 - B. Are above the legal blood alcohol limit but fine to drive
 - C. Can be very sure that you will drive safely
 - D. Should drink plenty of coffee before getting behind the wheel of your car
-

53. WHEN YOU HEAR A FIRE ENGINE SIREN, YOU MUST:

- A. Slow down until it passes you
 - B. Drive with your flashers on
 - C. Pull over to the side of the road and stop
 - D. Speed up and take the nearest exit
-

54. IF YOU HAVE A TIRE BLOWOUT, YOU SHOULD:

- A. Allow the steering wheel to move freely
 - B. Let the car slow to a stop
 - C. Continue driving until you reach a garage
 - D. Brake hard to stop the car immediately
-

55. IF YOUR CAR BREAKS DOWN ON A HIGHWAY, YOU SHOULD:

- A. Sit in your car and wait for help
 - B. Use your four-way flashers to warn other drivers
 - C. Sound your horn at passing motorists
 - D. Flash your headlights at oncoming traffic
-

56. WHEN YOU SEE AN EMERGENCY VEHICLE WITH FLASHING LIGHTS, YOU MUST:

- A. Slow down and keep moving in your lane
 - B. Keep driving in your lane
 - C. Pull to the curb and stop
 - D. Stop exactly where you are
-

57. WHEN DRIVING ON A ONE WAY STREET AND AN EMERGENCY VEHICLE WITH FLASHING LIGHTS IS BEHIND YOUR CAR, YOU:

- A. Drive with your flashers on
 - B. Drive toward the nearest road side and stop
 - C. Speed up and take the nearest exit
 - D. Slow down until the vehicle passes you
-

58. AFTER AN EMERGENCY VEHICLE PASSES YOU WITH ITS SIREN ON, YOU MUST:

- A. Drive closely to the police car
 - B. Drive as fast as the police car
 - C. Avoid driving closer than 500 feet behind the emergency vehicle
 - D. Drive near the curb very slowly
-

59. CRASHES IN WORK ZONES ARE MOST COMMONLY THE RESULT OF:

- A. Tire blow-outs
 - B. Hydroplaning because of water sprayed on the roadway
 - C. Loss of steering control after driving over wet paint
 - D. Carelessness and speeding
-

60. WHEN DRIVING THROUGH A WORK ZONE, IT IS A GOOD SAFETY PRACTICE TO:

- A. Drive close to the vehicle in front of you to keep traffic flowing freely
 - B. Shorten your usual following distance — by about half
 - C. Turn on your cruise control
 - D. Lengthen your usual following distance — by double
-

61. ON TWO-LANE, TWO-WAY STREETS OR HIGHWAYS, YOU SHOULD START LEFT TURNS:

- A. Close to the center line
- B. Close to the outside line
- C. In the center of the lane
- D. Anywhere in the lane

62. TO TURN LEFT ON MULTI-LANE STREETS AND HIGHWAYS, YOU SHOULD START FROM:

- A. The middle of the intersection
- B. The right lane
- C. The left lane
- D. Any lane

63. ON A TWO-LANE ROAD, YOU MAY PASS ANOTHER VEHICLE ON THE RIGHT WHEN:

- A. Driving on a single lane entrance ramp
- B. The driver you are passing is travelling slower than the posted speed limit
- C. Never
- D. The driver you are passing is making a left turn

64. TO PASS A SLOWER-MOVING VEHICLE ON A TWO-LANE ROAD YOU MUST:

- A. Not cross the center line
- B. Flash your lights to oncoming traffic
- C. Use the shoulder
- D. Use that lane that belongs to oncoming traffic

65. THESE PAVEMENT MARKINGS TELL YOU THAT AT THE INTERSECTION AHEAD:

- A. Center lane traffic may go straight or turn left
- B. You can only turn right from the center lane
- C. The center lane merges into one lane
- D. Center lane traffic must turn left



66. THE MOST IMPORTANT THING TO REMEMBER ABOUT SPEED MANAGEMENT AND CURVES IS TO:

- A. Drive at the posted speed limit as you enter the curve, then slow down at the sharpest part of the curve
- B. Slow down before you enter the curve
- C. Accelerate gently before you enter the curve
- D. Drive at the posted speed limit of the roadway, before, throughout, and after the curve

67. DRIVERS ENTERING A ROUNDABOUT OR TRAFFIC CIRCLE:

- A. Must stop before entering
- B. Must yield to drivers in the roundabout or traffic circle
- C. Have the right of way if they arrive first
- D. Have the right of way if there are two lanes

68. THE LAW GIVES _____ THE RIGHT OF WAY AT INTERSECTIONS.

- A. No one
- B. Drivers turning left
- C. Drivers going straight
- D. Drivers turning right

69. AT AN INTERSECTION WITH A STOP SIGN, YOU SHOULD STOP AND:

- A. Check your rearview mirror for cars tailgating
- B. Go when the vehicle ahead of you goes
- C. Look right first, then left, then right again
- D. Look left first, then right, then left again

70. WHEN ENTERING A HIGHWAY FROM AN ENTRANCE RAMP, YOU SHOULD GENERALLY:

- A. Enter above the speed of traffic to get ahead
 - B. Enter slowly to avoid other vehicles
 - C. Stop first, then slowly enter traffic
 - D. Accelerate to the speed of traffic
-

71. WHEN EXITING A HIGHWAY, YOU SHOULD SLOW DOWN:

- A. On the main road, just before the exit lane
 - B. Once you see the toll booth
 - C. Once you have moved into the exit lane
 - D. When you first see the exit sign
-

72. WHEN DRIVING ON A FREEWAY ENTRANCE RAMP, YOU SHOULD LOOK FOR A GAP IN FREEWAY TRAFFIC BY:

- A. Looking in the inside rearview mirror only
 - B. Looking in the sideview mirror only
 - C. Looking in both rearview and sideview mirrors
 - D. Looking in your mirrors and turning your head to look over your shoulder
-

73. IF YOU WANT TO GET OFF OF A FREEWAY, BUT YOU MISSED YOUR EXIT, YOU SHOULD:

- A. Go to the next exit, and get off of the freeway there
 - B. Make a U-turn through the median
 - C. Pull onto the shoulder and back your car to the exit
 - D. Flag down a police officer for an escort back to your exit
-

74. YOU ARE WAITING TO TURN LEFT AT A MULTILANE INTERSECTION, AND OPPOSING TRAFFIC IS BLOCKING YOUR VIEW, YOU SHOULD:

- A. Accelerate rapidly when the first lane you need to cross is clear
 - B. Wait until you can see all the lanes you need to cross before going ahead with your turn
 - C. Wait for the opposing driver to wave you across the intersection
 - D. Edge your car into each lane of opposing traffic as soon as it clears
-

75. WHEN NO SIGNS, SIGNALS, OR POLICE TELL YOU WHAT TO DO AT AN INTERSECTION, THE LAW STATES THAT:

- A. Drivers on the right must yield to drivers on the left
 - B. There are no laws stating who must yield
 - C. Drivers going straight must yield to drivers turning left at the intersection
 - D. Drivers turning left must yield to drivers going straight through the intersection
-

76. "HIGHWAY HYPNOSIS" IS A DRIVER CONDITION THAT CAN RESULT FROM:

- A. Staring at the roadway for long periods of time
 - B. Frequent rest stops
 - C. Too much sleep the night before your trip
 - D. Short trips on expressways
-

77. WHEN PASSING ON A MULTI-LANE HIGHWAY:

- A. Be sure the passing lane is clear
 - B. Pass only on the right
 - C. Watch for oncoming traffic
 - D. There is no need to signal
-

78. THE "FOUR-SECOND RULE" REFERS TO HOW ONE SHOULD:

- A. Yield to other cars
 - B. Turn at stop signs
 - C. Follow another car
 - D. Cross an intersection
-

79. IT IS BEST TO KEEP A SPACE CUSHION:

- A. Only in back of your vehicle
 - B. Only on the left and right side of your vehicle
 - C. Only in front of the vehicle
 - D. On all sides of the vehicle
-

80. ALLOWING A SPACE CUSHION IS IMPORTANT BECAUSE IT:

- A. Prevents distractions from other vehicles
 - B. Allows you time to react to situations
 - C. Keeps traffic flowing at a safe pace
 - D. Keeps other drivers alert
-

81. ALLOW A LARGER SPACE CUSHION WHEN STOPPING:

- A. On an up-hill
 - B. At an intersection
 - C. At a stop sign
 - D. At a toll plaza
-

82. WHEN MAKING A TURN, YOU MUST _____ YOUR SPEED.

- A. Increase
 - B. Maintain
 - C. Vary
 - D. Reduce
-

83. WHEN DRIVING IN TRAFFIC, IT IS SAFEST TO:

- A. Fluctuate your speed to keep alert
 - B. Drive faster than the flow of traffic
 - C. Drive slower than the flow of traffic
 - D. Drive with the flow of traffic
-

84. THE MAXIMUM SPEED LIMIT IN THIS STATE IS _____ MILES PER HOUR .

- A. 55
 - B. 50
 - C. 60
 - D. 70
-

85. DRIVE BELOW THE POSTED SPEED LIMIT WHEN:

- A. Anything makes conditions less than perfect
 - B. Others drive below the speed limit
 - C. Entering a highway where there are other cars
 - D. You are on a four lane road
-

86. THE AMOUNT OF SPACE YOU NEED TO CROSS TRAFFIC DEPENDS ON THE:

- A. Road and weather conditions and oncoming traffic
 - B. Presence of a stop sign
 - C. Use of your turn signals
 - D. Cars behind you
-

87. YOUR ABILITY TO STOP IS AFFECTED BY:

- A. Signal lights
 - B. Other cars on the road
 - C. The time of day
 - D. The condition of the road
-

88. WHICH OF THE FOLLOWING IS TRUE ABOUT THE SPEED AT WHICH YOU TRAVEL?

- A. The safe speed to drive depends on many conditions
 - B. Driving slowly is always safer
 - C. The speed limit is always a safe speed
 - D. Accelerating is always dangerous
-

89. TO PREPARE FOR ANYTHING COMING UP IN THE ROAD AHEAD, YOU SHOULD:

- A. Continually scan the entire road and roadsides
 - B. Stare straight ahead at all times
 - C. Drive with your left foot resting lightly on the brake pedal
 - D. Maintain focus toward the middle of the road
-

90. AT HIGHWAY SPEEDS, ON A DRY ROAD, A SAFE FOLLOWING DISTANCE IS AT LEAST:

- A. 3 seconds of following distance from the car ahead of you
 - B. 2 seconds of following distance from the car ahead of you
 - C. 4 seconds of following distance from the car ahead of you
 - D. 2 car lengths of following distance from the car ahead of you
-

91. WHAT CAN YOU DO TO AVOID THE NEED TO MAKE EMERGENCY (OR "PANIC") STOPS WHILE DRIVING IN TRAFFIC?

- A. Honk your horn to make others aware of your presence
 - B. Look ahead and maintain a safe following distance
 - C. Drive in the right lane only
 - D. Drive slower than the flow of traffic
-

92. WHEN FACED WITH ONE ONCOMING CAR TO THE LEFT AND A BICYCLIST TO THE RIGHT, YOU SHOULD:

- A. Pull onto the shoulder
 - B. Split the difference
 - C. Let the car pass and then pass the bike
 - D. Pass the bike quickly
-

93. IF AN ONCOMING DRIVER IS HEADING TOWARD YOU IN YOUR LANE, YOU SHOULD:

- A. Steer right, blow your horn, and accelerate
 - B. Steer left, blow your horn, and brake
 - C. Steer right, blow your horn, and brake
 - D. Stay in the center of your lane, blow your horn, and brake
-

94. IF THE REAR OF YOUR VEHICLE STARTS TO SKID LEFT, YOU SHOULD:

- A. Steer left
 - B. Hit your brakes
 - C. Accelerate
 - D. Steer right
-

95. THE MOST EFFECTIVE THING YOU CAN DO TO REDUCE YOUR RISK OF GETTING INJURED OR KILLED IN A TRAFFIC CRASH IS:

- A. Wear your seat belt
 - B. Limit your driving to week days
 - C. Stay in the right lane on multi-lane highways
 - D. Limit your driving to times between 3:00 p.m. and 6:00 p.m.
-

96. WHEN DRIVING ON SLICK ROADS, YOU SHOULD:

- A. Take turns more slowly
 - B. Change lanes quickly
 - C. Accelerate quickly
 - D. Brake hard
-

97. WHICH OF THE FOLLOWING IS TRUE ABOUT DRIVING ON A WET ROADWAY?

- A. As you drive faster, your tires become less effective
 - B. Water does not affect cars with good tires
 - C. Deeper water is less dangerous
 - D. As you decrease your speed, the roadway becomes more slippery
-

98. WHEN DRIVING ON SLIPPERY ROADS, YOU SHOULD:

- A. Use alternate routes
 - B. Drive as you would on dry roads
 - C. Increase your following distance
 - D. Avoid crossing bridges or intersections
-

99. WHEN DRIVING ON WET ROADS, YOU SHOULD:

- A. Drive the speed limit
 - B. Drive slightly faster than the speed limit
 - C. Drive 5 to 10 miles below the speed limit
 - D. Stay close to the vehicle ahead
-

100. WHEN DRIVING ON WET ROADS, YOU SHOULD:

- A. Increase following distance to 5 or 6 seconds
 - B. Decrease following distance to 2 seconds
 - C. Not be concerned about following distance
 - D. Maintain the 4-second following distance rule
-

101. ROADS FREEZE MORE QUICKLY WHEN THEY ARE:

- A. Flat
 - B. Curvy
 - C. In the sun
 - D. Shaded
-

102. ROADS BECOME VERY SLIPPERY:

- A. When it has been raining for an hour or more
 - B. The day after it rains
 - C. For the first 10 to 15 minutes of a rain storm
 - D. Right after the rain has stopped
-

103. HYDROPLANING IS USUALLY CAUSED BY:

- A. Excessive stops
 - B. Sudden stops
 - C. Sudden turns
 - D. Excessive speed
-

-
- 104. HYDROPLANING CAN BE HELPED BY DRIVING:**
- A. Through shallow water
 - B. Faster
 - C. Slower
 - D. Through deep water
-
- 105. WHEN DRIVING IN FOG, YOU SHOULD USE YOUR _____.**
- A. Low beam headlights
 - B. High beam headlights
 - C. Parking lights
 - D. Hazard flashers
-
- 106. COMPARED TO DRIVING DURING THE DAY, DRIVING AT NIGHT IS:**
- A. Less dangerous
 - B. No more of less dangerous
 - C. More dangerous
 - D. Easier on your eyes
-
- 107. ANYTHING THAT REQUIRES YOU TO _____ COULD CAUSE YOU TO CRASH.**
- A. Take your eyes off the road
 - B. Take your hands off the wheel
 - C. Take your attention away from the driving task
 - D. All of the above
-
- 108. DISTRACTED DRIVERS ARE AT A GREATER RISK OF A CRASH WHEN THEY ARE USING WHICH OF THE FOLLOWING:**
- A. CD player
 - B. Radio
 - C. Cell phone
 - D. All of the above
-
- 109. WHEN YOU ARE IN A LINE OF TRAFFIC THAT IS CROSSING A RAILROAD TRACK THAT HAS NO SIGNALS OR GATES:**
- A. You have the right of way and do not need to check for trains
 - B. You may pass slower drivers crossing the track
 - C. You need to make sure there is space to get all the way across the tracks without stopping, before you start to cross
 - D. All of the above
-
- 110. WHEN APPROACHING A STOPPED SCHOOL BUS WITH ITS RED LIGHTS FLASHING AND ITS STOP ARM EXTENDED, YOU MUST:**
- A. Stop 5 feet away from the bus
 - B. Stop only if you see children are present
 - C. Stop and remain stopped until it appears safe to proceed
 - D. Stop and remain stopped until the red lights stop flashing and the stop arm has been withdrawn
-

CHAPTER 3 ANSWER KEY

1.	C	41.	A	81.	A
2.	D	42.	A	82.	D
3.	C	43.	C	83.	D
4.	A	44.	A	84.	D
5.	B	45.	C	85.	A
6.	C	46.	B	86.	A
7.	A	47.	A	87.	D
8.	C	48.	B	88.	A
9.	C	49.	C	89.	A
10.	A	50.	A	90.	C
11.	B	51.	A	91.	B
12.	C	52.	A	92.	C
13.	B	53.	C	93.	C
14.	A	54.	B	94.	A
15.	A	55.	B	95.	A
16.	A	56.	C	96.	A
17.	A	57.	B	97.	A
18.	A	58.	C	98.	C
19.	A	59.	D	99.	C
20.	A	60.	D	100.	A
21.	A	61.	A	101.	D
22.	C	62.	C	102.	C
23.	C	63.	D	103.	D
24.	A	64.	D	104.	C
25.	D	65.	A	105.	A
26.	D	66.	B	106.	C
27.	A	67.	B	107.	D
28.	D	68.	A	108.	D
29.	A	69.	D	109.	C
30.	A	70.	D	110.	D
31.	C	71.	C		
32.	D	72.	D		
33.	C	73.	A		
34.	A	74.	B		
35.	D	75.	D		
36.	C	76.	A		
37.	C	77.	A		
38.	D	78.	C		
39.	A	79.	D		
40.	D	80.	B		

CHAPTER 4: DRIVING RECORD INFORMATION

This chapter provides important information about your driving record. PennDOT maintains a driving record for every licensed driver in Pennsylvania. The Bureau of Driver Licensing keeps reports on various offenses and convictions on every driver received from the police and courts. You can obtain a copy of your driving record on our website at www.dmv.pa.gov. You will need your driver's license number, date of birth, last four digits of your Social Security number and your credit card information.

THE PENNSYLVANIA POINT SYSTEM

The purpose of the point system is to help to improve driving habits and to ensure safe driving. Points are added to a driving record, when a driver is found guilty of certain driving violations. PennDOT begins to take corrective action when a driving record reaches six (6) or more points.

When a driving record reaches six (6) or more points for the first time, the driver will receive a written notice to take a written special point examination. When the driving record is reduced below six (6) points and reaches six (6) or more points for a second time, the driver will have to attend a Departmental hearing. Further accumulations of six (6) or more points will result in additional Departmental hearings and/or suspensions of your driving privilege.

In addition to these requirements, the driving privilege of a person under the age of 18 will be suspended if that person accumulates six (6) or more points or is convicted of driving 26 mph or more over the posted speed limit. The first suspension will be for a period of 90 days. Any additional occurrences will result in a suspension of 120 days.

A table showing the number of points given for specific traffic violations can be found at www.dmv.pa.gov, in "The Pennsylvania Point System" fact sheet.

POINT REMOVAL FOR SAFE DRIVING

Three (3) points are removed from a driving record for every 12 consecutive months in which a person is not under suspension or revocation or has not committed any violation, which results in the assignment of points or the suspension or revocation of the driving privilege. Once a driving record is reduced to zero and remains at zero points for 12 consecutive months, any further accumulation of points is treated as the first accumulation of points.

SUSPENSIONS AND REVOCATIONS

Your driving privilege will be suspended or revoked, if you are convicted of any one of the following traffic violations (this is only a partial listing):

- Operating a vehicle while under the influence of drugs or alcohol.
- Driving without lights to avoid identification.
- Felony involving a vehicle.
- Failure to stop when you are driving a vehicle involved in a crash (*hit-and-run offense*).
- Homicide by vehicle.
- Second or any additional offense of driving without a valid driver's license within a 5-year period.
- Reckless driving.
- Failure to stop for a school bus with its red lights flashing and stop arm extended (*60-day suspension*).
- Racing on highways.
- Failure to comply with a railroad crossing gate or barrier (*30-day suspension*).
- Fleeing from a police officer.
- Failure to comply with Move Over Law (*see page 59 for more information*).
- Driving when your driver's license is already suspended or revoked.

If your driving privilege is going to be suspended, revoked, and/or disqualified (sanction), a written notice will be mailed to you listing the date when the sanction will begin. Your driver's license and/or learner's permit or camera card must be returned to the Bureau of Driver Licensing by the effective date of the sanction listed on the notice or the state police and local police will be notified to pick up the driver's license.

All suspensions, revocations, and disqualifications (sanctions) will start on the effective date listed in the notice of sanction, regardless of when a driver's license or acknowledgment form is surrendered. Surrendering either of these items prior to the sanction effective date will not start the sanction early. By law, a driver's license or an acknowledgment form must be surrendered. You may appeal the sanction in the Court of Common Pleas (Civil Division) in your county of residence. The appeal must be filed within 30 days of the mailing date of the Department's notice. In addition to serving the sanction, all restoration requirements must be satisfied before your driving privilege will be restored.

After your driving privilege is restored, your driving record will show five (5) points, regardless of the number of points that appeared on your record before your driving privilege was suspended, except in the cases of:

- A 15-day suspension resulting from a hearing for the second accumulation of six (6) points.
- Suspension for failing to respond to a citation.

DRIVING WITHOUT INSURANCE

- According to Pennsylvania state law, **you must maintain automobile liability insurance on your registered vehicle at all times.**
- If PennDOT finds your vehicle was not covered by insurance for a period of 31 days or longer, your registration will be suspended for three (3) months. In addition, if you operated or permitted the operation of your vehicle without insurance, your driving privilege will also be suspended for a period of three (3) months.
- In order to have your driving privilege and registration restored, you must submit the following:
 - ◆ Proof your vehicle is currently insured.
 - ◆ The required restoration fees.

WHAT TO DO IF YOU ARE STOPPED BY THE POLICE

Law enforcement officers issue written traffic citations to persons who are charged with violating the Pennsylvania Motor Vehicle Law. You must follow the directions of the officer at the time of the stop or you may be subject to arrest. You will know a police officer wants you to pull over when they activate the flashing red and blue lights on top of the police vehicle. In some instances, an unmarked police vehicle may be equipped with a flashing red light only.

Anytime a police vehicle stops behind you, for your safety and the safety of others, police recommend you do the following:

- | | |
|--|---|
| <ul style="list-style-type: none"> • Activate your turn signal and drive as close as safely possible to the right edge of the road, stop, and park your vehicle safely away from traffic. • Turn off your engine and radio, and roll down your window so you can communicate with the officer. • Turn on your vehicle's interior light as soon as you stop and before the officer approaches, if it is nighttime. • Limit your movements and the movements of your passengers - do not reach for anything in the vehicle. • Alert the officer immediately, if you are transporting any type of firearm. • Place your hands on the steering wheel, and ask any passengers to have their hands in view. • Keep your vehicle doors closed as the officer approaches, and stay inside your vehicle, unless the officer asks you to get out. | <ul style="list-style-type: none"> • Keep your seat belt fastened until the officer has seen you are appropriately restrained. • Wait until the officer asks you to retrieve your driver's license, registration and insurance cards. Do not hand the officer your wallet - just the requested items. • Always be polite. The officer will tell you what you did wrong. You may receive only a warning or you may be cited for a traffic violation. If you disagree with the citation, you are entitled to a court hearing where you can present your arguments. It is not in your best interest to argue with the officer at the scene. If you believe you have not been treated in a professional manner, you should contact the appropriate police department at a time following the traffic stop, and ask for a supervisor. |
|--|---|

Remember, police lights can be red and blue, or could be red only on unmarked police vehicles. You may also see flashing white lights used in addition to these lights. **If the vehicle is flashing only blue lights, then it is not a police officer.** If you see flashing red and blue lights or flashing red lights only and you are still not certain the person pulling you over is actually a police officer, you may drive to the nearest well-lit, populated area, but acknowledge you understand the request to stop by turning on your flashers and driving at a reduced speed. You may ask the officer for identification, and should do so if the individual who has stopped you is not in uniform or has an unmarked vehicle. Most officers in unmarked vehicles are wearing police uniforms, and police officers always possess a photo ID card and a badge.

CRASHES

Do not stop at a crash unless you are involved or if emergency help has not yet arrived. Keep your attention on your driving and keep moving, watching for people who might be on or near the road. Do not block the way for police, firefighters, ambulances, tow trucks and other rescue vehicles.

If you are in a crash, you should do the following:

1. Stop your vehicle at or near the crash scene. If you can, move your vehicle off of the road so you do not block traffic. Many crashes are caused when traffic stops or slows for an initial crash.
2. Call the police, if anyone is hurt or dies. If the drivers of the vehicles are hurt and cannot call the police, then witnesses at or near the crash scene must call for help.
3. Call the police, if any vehicle needs to be towed.
4. Get the information listed below from the other driver(s) involved in the crash:
 - Names and addresses
 - Telephone numbers
 - Registration numbers
 - Insurance company names and policy numbers
5. Get the names and addresses of other individuals involved in the crash and any witnesses of the crash.
6. If the crash involves a parked vehicle or damage to property, stop immediately, and try to find the owner. If you cannot find the owner, leave a note in a place where it can be seen and call the police. The note should include the date and time of the crash, your name and a telephone number where you can be reached.
7. If the police do not investigate a crash and someone has died or been injured, or if a vehicle must be towed, send a Driver's Accident Report Form (AA-600) within five (5) days to:

PA Department of Transportation
 Bureau of Highway Safety & Traffic Engineering
 P.O. Box 2047
 Harrisburg, PA 17105-2047

Please note:
 To obtain a Driver's Accident Report Form (AA-600), visit our website at www.dmv.pa.gov, or contact your local or state police.

FLEEING OR ELUDING POLICE

Each year, there are about 450 crashes caused when a driver attempts to flee or elude police, resulting in 40 to 50 major injuries or fatalities on Pennsylvania roadways.

If a driver is convicted of fleeing or attempting to elude police, the penalty is a one-year suspension of the driving privilege, a fine of \$500, plus court costs and other fees, and could include imprisonment.

DRIVING UNDER THE INFLUENCE OF ALCOHOL OR A CONTROLLED SUBSTANCE

WHAT CONSTITUTES A DUI (DRIVING UNDER THE INFLUENCE)?

The penalties for driving while under the influence of alcohol or drugs are severe. In Pennsylvania, if you are of legal drinking age (21 or older), you are considered to be driving "while under the influence" **if your blood alcohol level is .08 or higher.** But, you also may be convicted of DUI at lower BAC levels, if you are stopped by police for driving erratically (too slow, too fast, straddling your lane, making wide turns, stopping for no reason, failing to obey traffic signs and signals, etc.).

If you are under age 21, Pennsylvania's laws do not permit you to drive with any measurable alcohol in your system. If you are under 21, you are considered to be driving under the influence if your blood alcohol level is .02 or greater.

PENNSYLVANIA'S IMPLIED CONSENT LAW (CHEMICAL TESTING FOR ALCOHOL OR DRUGS)

The Implied Consent law is very important to you as a driver. The law covering chemical testing says you have agreed to take such a test -- just by being licensed to drive in Pennsylvania. If the police arrest you for driving while under the influence of alcohol or drugs and you refuse to take one (1) or more chemical tests of breath or blood, your driving privilege will be automatically suspended for one (1) year. This suspension is in addition to the suspension imposed for a conviction or Accelerated Rehabilitative Disposition (ARD) for driving while under the influence.

Even if you are found not guilty of driving while under the influence, your driving privilege will be suspended for one (1) year for a first-time refusal to take a breath or blood test. If you refuse to take a test and you are found guilty of DUI, your driving privilege may be suspended for two and a half (2 1/2) years, depending on your BAC level at the time of the arrest. If you refuse chemical testing and have had a prior DUI conviction or a prior refusal for chemical testing, you will face an 18-month suspension for the refusal, plus 18 more months for the DUI conviction, for a total suspension of three (3) years.

CHEMICAL TEST REFUSAL RESTORATION FEE

Drivers who refuse to submit to a chemical test will be required to pay a chemical test refusal restoration fee. First offense is \$500, second offense is \$1,000, and third or subsequent offense is \$2,000. The chemical test refusal restoration fee is in addition to the restoration fee required under the Pennsylvania Vehicle Code, Title 75, section 1960. A chemical test refusal restoration fee must be paid by certified check or money order.

SEVERE PENALTIES

The penalties become more severe for these three (3) things: the higher your blood alcohol concentration, the more serious the injuries and damages resulting from a crash while driving under the influence, and the more times you are convicted for DUI.

The following three (3) tables summarize the penalties for driving under the influence at different levels of impairment. In addition to the penalties listed in these tables, alcohol highway safety school will be required for first or second offenses at any level of impairment. First-time and repeat DUI offenders with high blood alcohol levels and individuals who receive an operating privilege suspension as a result of a chemical test refusal violation will be required to have an Ignition Interlock system installed in any motor vehicle to be operated. An individual with an Ignition Interlock requirement who seeks restoration of their operating privilege, is required, as a condition of issuing a restricted license, to either have any motor vehicle to be operated equipped with an Ignition Interlock system and remain so for the duration of the restricted license period or, if there are no motor vehicles owned, registered, or to be operated, to certify in accordance with PennDOT's regulations. You may also be required by the court to undergo an alcohol abuse screening and treatment at any level of impairment for first and subsequent offenses. Additionally, a judge may impose up to 150 hours of community service.

If you are under 21 years of age and you are convicted of driving under the influence (your BAC is .02 or higher), you will be subject to the penalties listed in Table 2, "High Rate," even if your BAC is less than the levels specified for those penalties.

If you are involved in a crash resulting in bodily injury, death or property damage, you are subject to the penalties listed in Table 2, "High Rate," rather than those listed in Table 1, "General Impairment," even if your BAC is lower than the levels listed in Table 2, "High Rate."

Anyone who drives under the influence of controlled substances and drivers who refuse a chemical test are subject to the penalties listed in Table 3, "Highest Rate."

For a first offense at the high and highest rates of impairment, you may be accepted into the Accelerated Rehabilitative Disposition (ARD) program.

TABLE 1 - GENERAL IMPAIRMENT: .08 TO .099 BLOOD ALCOHOL CONCENTRATION <i>(Note: These penalties apply to drivers of legal drinking age.)</i>			
Penalty	First Offense	Second Offense	Third Offense
Sentence	6 months probation	5 days to 6 months in prison	10 days to 2 years in prison
Fine	\$300	\$300 - \$2,500	\$500 - \$5,000
License	No action	12-month suspension and 1 year Ignition Interlock requirement	12-month suspension and 1 year Ignition Interlock requirement

TABLE 2 - HIGH RATE: .10 TO .159 BLOOD ALCOHOL CONCENTRATION <i>(Note: This table also applies to drivers under age 21 with a BAC of .02 or more; commercial vehicle drivers with a BAC of .04 or more; school bus drivers with a BAC of .02 or more; and drivers with BAC of .08 to .099 and who are involved in a crash resulting in serious bodily injury, death or vehicle or property damage.)</i>			
Penalty	First Offense	Second Offense	Third Offense
Sentence	2 days to 6 months in prison	30 days to 6 months in prison	90 days to 5 years in prison
Fine	\$500 - \$5,000	\$750 - \$5,000	\$1,500 - \$10,000
License	12-month suspension and 1 year Ignition Interlock requirement	12-month suspension and 1 year Ignition Interlock requirement	18-month suspension and 1 year Ignition Interlock requirement

TABLE 3 - HIGHEST RATE: .16 BLOOD ALCOHOL CONCENTRATION AND UP <i>(Note: This table also applies to drivers who refuse chemical testing at any BAC level and drivers convicted of driving under the influence of Schedule I, II or III substances that are not medically prescribed, a combination of another drug and alcohol or substances such as inhalants.)</i>			
Penalty	First Offense	Second Offense	Third Offense
Sentence	3 days to 6 months in prison	90 days to 5 years in prison	1 year to 5 years in prison
Fine	\$1,000 - \$5,000	\$1,500	\$2,500 minimum
License	12-month suspension and 1 year Ignition Interlock requirement	18-month suspension and 1 year Ignition Interlock requirement	18-month suspension and 1 year Ignition Interlock requirement

If your penalty includes a maximum probation or prison term of six (6) months (you are a first-time offender at any level or a second-time offender in the "General Impairment" or "High Rate"), your DUI crime has been charged as an ungraded misdemeanor. The charge of ungraded misdemeanor means if you contest the case, you are not entitled to a jury trial.

For a first offense at the high and highest rates of impairment, you may be accepted into the Accelerated Rehabilitative Disposition (ARD) program.

- | | |
|--|---|
| If you are accepted into the ARD program you will: | |
| <ul style="list-style-type: none"> • Lose your license for up to 90 days for ARD. • Remain under court supervision for six (6) months. • Pay a fine of between \$300 and \$5,000 in addition to related fees and other costs. | <ul style="list-style-type: none"> • Undergo alcohol and drug evaluation. • Undergo alcohol and drug rehabilitation treatment, if necessary. • Participate in 12 1/2 hours of Alcohol Highway Safety School. |

ZERO TOLERANCE LAW (UNDER 21 DUI)

The Zero Tolerance law establishes serious consequences for those under 21, who drive with any measurable amount of alcohol in their blood. The law reduced the Blood Alcohol Content (BAC) from .08 to .02 for minors (under 21) charged with Driving Under the Influence.

WHY ZERO TOLERANCE?

Traffic crashes are the number one (1) cause of death for teenagers in the United States.

Driving involves multiple tasks, the demands of which change continually. To drive safely, you must be alert, make decisions based on ever-changing information present in the environment and be able to maneuver based on these decisions. Drinking alcohol impairs a wide range of skills necessary for carrying out these tasks.

If you are under 21 and are convicted of DUI for the first time, you will go to jail for a term ranging from two (2) days to six (6) months, your license will be suspended for a full year, and you will pay a fine of \$500 to \$5,000.

UNDERAGE DRINKING

If you are under age 21, it is against the law to buy alcohol, consume alcohol, have alcohol in your possession or have alcohol in the vehicle you are driving. In addition, if you are underage and are arrested and detained for blood, breath and/or urine testing, parental consent to conduct these tests is not required, but the police will notify your parents of the arrest. The minimum penalty for underage drinking is a fine of up to \$500 plus court costs.

The courts may require you to be evaluated to determine the extent of your involvement with alcohol and may also require you to successfully complete a program of alcohol education, intervention or counseling.

ONE FACT REMAINS: It is against the law for anyone under age 21 to consume, possess or transport alcohol.

DO NOT risk the consequences.

Adults, even parents, who are convicted of knowingly and intentionally supplying minors with alcohol are subject to a fine of at least \$1,000 for the first offense and \$2,500 for each additional offense and face up to one year in jail. Adults are even liable for guests who drink in their homes. If, for example, you had 17 teenagers in your home for a party and they were drinking alcohol, the party could cost you \$41,000. That's \$1,000 for the first teenage drinker and \$2,500 for each of the other 16 drinkers.

DRIVER'S LICENSE COMPACT (DLC)

The DLC is a compact among member states and the District of Columbia to maximize law enforcement efforts nationwide. The major provisions of the DLC, which member states are committed to uphold and enforce, are:

- The "one driver's license" concept, which requires the surrender of an out-of-state driver's license when application for a driver's license in another state is made.
- The "one driver record" concept, which requires that a complete driver record be maintained in the driver's state of residence to determine driving eligibility in the home state, as well as for their non-resident operator's privilege in other jurisdictions.
- Reporting of all traffic convictions and driver's license suspensions/revocations of out-of-state drivers to the home state licensing agency, as well as other appropriate information.
- The assurance of uniform and predictable treatment of drivers by treating offenses committed in other states as though they have been committed in the home state.

The following offenses, if committed in a member state, would be treated as though the offense had occurred in Pennsylvania, and the appropriate sanction would be imposed under the provisions of our Vehicle Code:

- Manslaughter or negligent homicide resulting from the operation of a vehicle (Section 3732).

- Driving a vehicle while under the influence of alcoholic beverages or a narcotic to a degree rendering the driver incapable of safely driving a vehicle (Section 3802).
- Failure to stop and render aid in the event of a vehicle accident resulting in the death or personal injury of another (Section 3742).
- Any felony in the commission of which a vehicle is used (Crimes Code and Dangerous Drug Act Offenses).

Not responding to an out-of-state citation will result in the indefinite suspension of your Pennsylvania driving privilege until a response is made to the location indicated on the citation.

CHAPTER 4 REVIEW QUESTIONS

1. **THE MINIMUM DRINKING AGE IN THIS STATE IS ____ YEARS.**
 - A. 9
 - B. 20
 - C. 21
 - D. 18

2. **PEOPLE UNDER 16 YEARS OF AGE WHO USE A FALSE IDENTIFICATION CARD TO BUY ALCOHOL WILL:**
 - A. Receive a driving suspension that starts on their 16th birthday
 - B. Not be able to take the driver's exam until their 21st birthday
 - C. Receive a driving suspension that starts on their 21st birthday
 - D. Be sent to an alcohol safety education class

3. **IF A PERSON UNDER 21 YEARS OLD CONSUMES ALCOHOL, BUT IS NOT DRIVING A MOTOR VEHICLE, THE PENALTY FOR A FIRST OFFENSE IS:**
 - A. A 90-day driver license suspension and up to a \$500 fine
 - B. A 6-month probation
 - C. Sentence to a corrections institution
 - D. Points on the driving record

4. **PARENTAL CONSENT TO CONDUCT BREATH, BLOOD, AND URINE TESTS IS:**
 - A. Not required
 - B. Required from only one parent
 - C. Required for people under 16 years old
 - D. Required from both parents

5. **IT IS AGAINST THE LAW FOR ANYONE UNDER THE AGE OF 21 TO _____ ALCOHOL.**
 - A. Wear clothing advertising
 - B. Be in the presence of
 - C. Consume
 - D. Serve

6. **IT IS AGAINST THE LAW FOR ANYONE UNDER THE AGE OF 21 TO _____ ALCOHOL.**
 - A. Wear clothing advertising
 - B. Possess
 - C. Serve
 - D. Be in the presence of

7. **IT IS AGAINST THE LAW FOR ANYONE UNDER THE AGE OF 21 TO _____ ALCOHOL.**
 - A. Serve
 - B. Wear clothing advertising
 - C. Be in the presence of
 - D. Transport

8. **ONE OF THE PENALTIES FOR DRIVING UNDER THE INFLUENCE OF ALCOHOL IS A(N):**
 - A. 5 – year driver's license suspension
 - B. \$100.00 fine
 - C. Attendance to Alcohol Highway Safety School
 - D. 12 – hour sentence in jail

9. IF YOU ARE ARRESTED FOR DRIVING UNDER THE INFLUENCE OF ALCOHOL AND YOU REFUSE TO TAKE THE BLOOD TEST, YOU WILL RECEIVE A:

- A. Drug counseling treatment
 - B. Sentence of one day in jail
 - C. Driver's License Suspension
 - D. \$300.00 fine
-

10. IF A POLICE OFFICER REQUIRES YOU TO TAKE A BLOOD, BREATH, OR URINE TEST, YOU:

- A. May choose the test you prefer
 - B. Must sign a consent form
 - C. May refuse if underage
 - D. Must take the test, or your license will be suspended
-

11. FOR A FIRST CONVICTION FOR DRIVING UNDER THE INFLUENCE AT ANY BLOOD ALCOHOL CONCENTRATION LEVEL, YOU COULD:

- A. Lose your license for up to 5 years
 - B. Be required to conduct a public education class on the dangers of drunk driving
 - C. Be required to drive with a restricted occupational license
 - D. Pay a fine of at least \$300
-

12. IF UNDER 21 YEARS OF AGE YOU ARE CONSIDERED TO BE DRIVING WHILE UNDER THE INFLUENCE IF YOUR BLOOD ALCOHOL LEVEL IS:

- A. .08% or higher
 - B. .10% or higher
 - C. .05% or higher
 - D. .02% or higher
-

13. IF YOU ARE UNDER AGE 21 AND ARE CONVICTED OF DRIVING UNDER THE INFLUENCE OF ALCOHOL, YOU WILL RECEIVE A ____ LICENSE SUSPENSION FOR A FIRST OFFENSE.

- A. 60-Day
 - B. 30-Day
 - C. 6-Month
 - D. 1-Year
-

14. IF YOU ARE UNDER AGE 21, AND ARE CONVICTED OF CARRYING A FALSE ID CARD, YOU WILL BE REQUIRED TO PAY A \$500 FINE AND YOUR LICENSE WILL BE SUSPENDED FOR 90 DAYS.

- A. Only if your blood alcohol content (BAC) is .02% or higher
 - B. Even if you were not driving
 - C. Only if you were driving at the time of arrest
 - D. Only if your blood alcohol content (BAC) is .02% or higher and you were driving at the time of arrest
-

15. THE ZERO TOLERANCE LAW REDUCED THE BLOOD ALCOHOL CONTENT (BAC) FROM .08% TO ____ FOR DRIVERS UNDER 21 TO BE CHARGED WITH DRIVING UNDER THE INFLUENCE.

- A. .02%
 - B. .05%
 - C. .07%
 - D. .00%
-

16. IF YOU ARE STOPPED BY A POLICE OFFICER, YOU SHOULD:

- A. Unbuckle your seat belt and lower your window
 - B. Get your paperwork ready before the officer reaches your car
 - C. Stay in your vehicle with your hands on the steering wheel, and wait for the officer to approach you
 - D. Get out of your car and walk toward the patrol car
-

CHAPTER 4 ANSWER KEY

1. C
2. A
3. A
4. A
5. C
6. B
7. D
8. C
9. C
10. D
11. D
12. D
13. D
14. B
15. A
16. C

CHAPTER 5: LAWS AND RELATED ISSUES

This chapter will provide information you need to know about recent Pennsylvania laws or other relevant driver related laws.

For more information on Pennsylvania laws please visit www.dmv.pa.gov, select laws and regulations listed under Information Centers.

REQUIRED NOTIFICATION FOR CHANGE IN NAME OR ADDRESS

In accordance with Section 1515 of the Pennsylvania Vehicle Code, if your name or address is changed, you must notify PennDOT within 15 days of that change even if moving out of state. You may report your address change by visiting our website at www.dmv.pa.gov or calling our Customer Call Center at 717-412-5300. The Pennsylvania Vehicle Code prohibits the issuance of driver license products to anyone who is not a resident of Pennsylvania. By law, if you are a registered voter in Pennsylvania, this application will allow us to notify your county voter registration office of your address change. You may change your name by completing a Non-Commercial Driver's License Application for Change/Correction/Replacement (Form DL-80) available on the website. You will be issued a driver's license update card containing the new information. This card must be carried with your driver's license. There is no fee for this service for non-commercial drivers.

SEAT BELT LAW

In accordance with Section 4581 of the Pennsylvania Vehicle Code, it is a law in Pennsylvania that:

- All drivers and front seat passengers in vehicles, light trucks and motor homes must wear seat belts.
- If you are transporting passengers age eight (8) or older but less than age 18, they must wear seat belts, no matter where they are riding in the vehicle.
- If you are a driver under the age of 18, the number of passengers may not exceed the number of seat belts in the vehicle.

YOU ARE REQUIRED BY LAW TO BUCKLE UP. It makes good sense to wear your seat belt.

Many people believe they would be able to use their arms and legs to stop themselves from hitting the vehicle's surfaces in a crash, but they are wrong. In a collision, your vehicle stops, but your body keeps moving at the same speed you were traveling until it hits the instrument panel or windshield. In most crashes, the bodies of the passengers and drivers hit the vehicle's interior surfaces with several tons of force. This will shatter even the strongest arms and legs. At 30 mph, this is like hitting the ground from the top of a three-story building. This is why you cannot catch yourself with your arms. A driver or passenger who is not buckled up, can be killed on impact even when the vehicle is traveling as slowly as 12 mph.

Only seat belts can safely slow your body. You have only 1/50th of a second to stop your body after the vehicle crashes. Arms and legs do not work that quickly, but seat belts do. Seat belts slow your body down far more gently than a hard instrument panel, steering wheel or windshield does. During a crash, fastened seat belts distribute the forces of rapid deceleration over larger and stronger parts of your body such as the chest, hips and shoulders. Air bags provide an even greater "ride down" benefit. However, even with an air bag present, a seat belt must be worn.

Seat belts also keep you inside of your vehicle. Your chances of being killed are almost 25 times greater if you are thrown from your vehicle. Being thrown clear usually means going through the windshield and then landing somewhere - hard. The forces in a collision can be great enough to fling you as much as 150 feet (about 15 vehicle lengths). If you land in the street, there is always the chance of being run over while you lie there. Four (4) out of every five (5) people who were killed by being thrown clear would have lived, if they had been able to stay inside the vehicle.

Seat belts and air bags save lives. They work best when everyone is buckled and children are properly restrained in the back seat.

CHILD RESTRAINT LAW

Vehicle crashes are the leading cause of death and injury to children in the United States. In Pennsylvania each year, approximately 7,000 children under five (5) years of age are involved in crashes.

CHILD PASSENGER PROTECTION ACT 229 REQUIRES

- Children under the age of four (4) must be buckled into a federally-approved child passenger restraint system (child safety seat), which must be secured to the vehicle by the seat belt system (or using the vehicle's LATCH system, available in newer vehicles), no matter where they ride in the vehicle (front or back seat).
- Children ages four (4) and older, but under the age of eight (8) must be buckled into a federally-approved child booster seat, which must be secured to the vehicle by the seat belt system, no matter where they ride in a vehicle (front or back seat). Booster seats must be used in conjunction with lap and shoulder belts.
- Children ages eight (8) and older, but under age 18 must be buckled in a seat belt, no matter where they ride in the vehicle (front or back seat).
- Drivers are responsible for securing children into an approved child passenger restraint system and ensuring children under age 18 are buckled up.

VIOLATORS MAY BE FINED AND WILL BE RESPONSIBLE FOR ALL COURT COSTS.

Children younger than age 2 must be secured in a rear-facing car seat until the child outgrows the maximum weight and height limits of the car seat as designated by the car seat manufacturer. **Never install a rear-facing child safety seat in the front seat if an air bag is present.** In a crash, the air bag will hit the back of the child seat with tremendous force, which will be transmitted to the infant's head causing severe injury or death.

If you are transporting children under age eight (8) who, by law, must ride in federally-approved child safety seats or booster seats, read your vehicle owner's manual and the directions that came with the seat so you know how to tightly attach the seat to your vehicle's seat and how to secure the children snugly in their child seats.

SAFETY TIPS FOR CHILDREN AND PETS

Prevent Vehicle Related Heatstroke

As outside temperatures rise, the dangers for children and pets being seriously injured or even dying from being left alone inside a hot car also rise. Vehicles heat up quickly - even with a window rolled down two inches, if the outside temperature is in the low 80s Fahrenheit, the temperature inside a vehicle can reach deadly levels in only 10 minutes.

Prevention Tips to Avoid a Tragic Heatstroke:

- Never leave a child or pet alone in a car, even if the windows are partially open.
- Never let kids play in an unattended vehicle.
- Place your purse, briefcase, cell phone, or something you will need in the back seat so you will be sure to see a child left in the vehicle.
- Keep a large teddy bear or other stuffed animal in the car seat when it is empty. Move the item to the front seat when you place the child in the car seat as a visual reminder.
- For additional information about preventing heatstroke, visit <https://www.safercar.gov/parents/InandAroundtheCar/heatstroke.htm>.

Winter coats and car seats

As the coldest part of winter approaches, parents bring out their child's bulky winter coats to keep them warm during vehicle travel. However, thick winter coats can reduce the safety of the child's car seat. All coats and clothing will compress in a crash, but thicker winter coats can compress enough to create significant slack in the harness. The car seat harness keeps the child secure in the car seat and must be snug on the child's body to provide the best protection in a crash. For additional information regarding Winter Safety Tips for Children, visit PennDOT's website at <http://www.penndot.gov>.

AIR BAG SAFETY INFORMATION

- Air bags are supplemental protection devices. Lap and shoulder belts should always be worn. Wear the seat belt snugly across your hips and the shoulder strap across your chest away from your neck.
- Driver and front passenger seats should be moved as far back as practical, particularly for shorter people. You should sit as far away from the air bag compartment as possible, without compromising your ability to reach and operate the gas and brake pedals, and controls on the instrument panel and steering column. To be safe, in case the air bag deploys, you should be at least 10 inches away from the steering wheel.
- Hold the steering wheel at the 9 and 3 o'clock or 8 and 4 o'clock positions. This will keep your wrists and arms from being injured or broken or forcibly hitting you in the face, if the air bag deploys. Also, keep your thumbs on the top or outside rim of the wheel, instead of gripping the inside of the wheel.
- Infants in rear-facing safety seats should **never** ride in the front seat of a vehicle with a passenger side air bag.
- It is recommended that all children ages 12 and under ride in the rear seat. There are two (2) reasons for this: first, most collisions are frontal collisions, so placing children in the back seat moves them farther away from the point of impact; second, children tend to fidget in their seats and may get too close to the air bag compartment if they are in a front seat, putting them at risk of injury in the event the air bag deploys during a crash.

AMERICANS WITH DISABILITIES ACT (ADA)

In order to comply with the Americans with Disabilities Act of 1990, PennDOT has made all Driver License Centers and Photo License Centers accessible to physically disabled individuals. In addition, the following services are available to people who want to take the Knowledge and Road Test and have a hearing or reading impairment.

INTERPRETERS FOR THE DEAF AND HEARING IMPAIRED

PennDOT's Bureau of Driver Licensing will provide an interpreter upon request for individuals who are hearing impaired and communicate through the use of sign language. This service is available for customers who want to take the driver's Knowledge and/or Road Test or have to take a special point exam.

Make your initial contact with PennDOT at least two (2) weeks prior to the time you want to take the test, and PennDOT will do its best to secure a person who signs in your preference.

IN ORDER FOR AN INTERPRETER TO BE PRESENT YOU MUST

1. Call 717-412-5300 to schedule an appointment to take your test. If you use a TDD, you should call 711. Indicate at which Driver License Center you want to take the test and give at least three (3) dates you will be able to take the test.

When setting up an appointment to take your test, you may also use the Pennsylvania Relay Service. This service provides telephone communication between a person who has a TDD system and one who does not. This system uses an operator to act as a go between for calls between hearing and non-hearing parties. If you have a TDD system, you should use 1-800-654-5984 when accessing the Pennsylvania Relay Service. If you are accessing the service as a hearing caller, you should use 1-800-654-5988. When an interpreter has been hired to assist you with your test, you will be called back to have your test date confirmed.

2. When making your appointment, you should indicate if there is a type of sign language you prefer to use. The types available are:
 - American Sign Language (ASL)
 - Pidgin Sign Language (PSE)
 - Signed Exact English (SEE)
 - An oral interpreter (a person who reads lips)

ALTERNATIVE TESTING METHOD

Some people who take the Knowledge Test may have trouble reading or in some cases, may not be able to read and would feel more comfortable if the test were read to them. Upon request, voice tests are offered at all Driver License Centers across the commonwealth.

PARKING AREAS FOR PERSONS WITH DISABILITIES

According to Pennsylvania law, there are two (2) conditions necessary before an individual may legally park in a designated parking area for persons with disabilities:

1. The vehicle being parked must display a disabled person or disabled veteran registration plate/parking placard.
2. The vehicle must be operated by or for the transportation of the disabled person or severely disabled veteran.

Any vehicle unlawfully parked in a parking area for disabled persons may be removed from that area by towing and reclaimed upon payment of the towing costs. This parking violation is a summary offense. Individuals convicted of this offense will be fined between \$50 and \$200.

ANTI-LITTERING LAW

It is against the law to drop, throw or deposit upon any highway, upon any other public or private property (without the consent of the owners thereof) or into or on the waters of this commonwealth, from a vehicle, any waste paper, sweepings, ashes, household waste, glass, metal, refuse or rubbish or any dangerous or detrimental substance, or permitting any of the preceding without immediately removing such items or causing their removal. A violation of this law, including any violation resulting from the conduct of any other persons present within any vehicle of which you are the driver, may result in a fine of up to \$300 upon conviction.

VEHICLE SAFETY AND EMISSIONS INSPECTION

Your vehicle must have a safety inspection at an authorized inspection station every 12 months. The date on the sticker tells you when your vehicle must be inspected again. A vehicle may be inspected up to 90 days before its next expiration date. Also, if a police officer notices faulty equipment on your vehicle, you may be required to fix it within five (5) days to avoid a citation. In many counties, you must also get the emissions control system for your car, van or light-duty truck (model year 1975 or newer) inspected before you can complete your safety inspection. Emissions inspections are performed at privately owned businesses certified by PennDOT. Call the Emissions Customer Hotline at 1-800-265-0921 to learn about the requirements in your county.

SAFE PASSING IS THE LAW

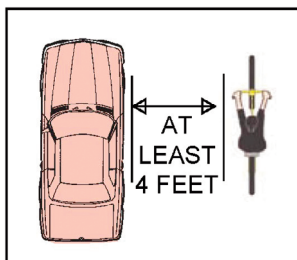

1. Before passing, you must first decide whether you can maneuver around the bicyclist. Be sure to check for oncoming traffic. When passing, you **must allow at least four (4) feet** between your vehicle and a bicycle in order to pass safely. If necessary and if you can do it safely, you are permitted to cross the center double yellow line so you can maintain the four (4) feet of clearance between your vehicle and the bicycle.
2. Unless making a left turn, bicyclists traveling more slowly than passing vehicles must keep to the right side of the roadway and must travel in the same direction as the rest of traffic. However, this requirement is waived on roads with a single lane in each direction.
3. When there is only one travel lane, bicyclists may use any portion of the lane to avoid hazards on the roadway, including keeping a safe distance from stopped and parked cars.
4. Drivers cannot turn into the path of a bicyclist who is riding straight ahead on a roadway or shoulder.
5. You cannot force a bicyclist off the road. If you do this, you may face criminal charges.
6. Bicyclists are considered to be vehicle operators and are expected to obey all traffic laws; however, they may travel at less than the posted minimum speed and may not be cited for impeding traffic. Bicyclists may operate on a shoulder or berm, but are not required to do so.

For more information, the Pennsylvania Bicycle Driver's Manual (PUB 380) can be found at:
<http://www.dot.state.pa.us/public/pubsforms/Publications/Pub%20380.pdf>

THE DANGER OF OPEN DOORS TO BICYCLISTS

Open vehicle doors pose a very serious threat to bicyclists. When opening a vehicle door, drivers and passengers are suggested to do the following:

1. Check your rear-view mirror.
2. Check your side-view mirror.
3. Open the door with your far hand (the hand farther from the door)

This is called the "Dutch Reach" method because it originated in the Netherlands. It forces your body to turn, which will better allow you to see approaching bicyclists. It also prevents the vehicle door from being opened too fast. This not only protects bicyclists, but can also prevent your door from being damaged or torn off by an approaching motor vehicle.

Bicyclists should ride at least three feet from parked cars to avoid doors, both on streets with and without bike lanes. This will keep bicyclists outside of the "door zone" and protect them from getting hit by opening vehicle doors.

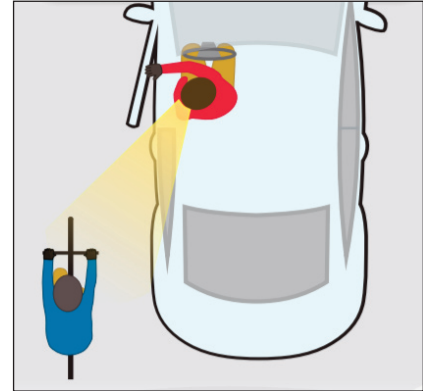

ANTI-TEXTING LAW

The law went into effect March 8, 2012, and violating the law is a primary, summary offense with convictions carrying a \$50 fine.

What the Law Does

- Defines an Interactive Wireless Communication Device (IWCD) as a wireless phone, personal digital assistant, smart phone, portable or mobile computer or similar devices that can be used for texting, instant messaging, emailing or browsing the Internet.
- Defines a text-based communication as a text message, instant message, email or other written communication composed or received on an IWCD.
- Makes clear that this law supersedes and preempts any local ordinances restricting the use of interactive wireless devices by drivers.

The law does not authorize the seizure of an IWCD. The texting ban does not include the use of a GPS device, a system or device that is physically or electronically integrated into the vehicle, or a communications device that is affixed to a mass transit vehicle, bus or school bus.

OBEDIENCE TO TRAFFIC-CONTROL DEVICES WARNING OF HAZARDOUS CONDITIONS LAW

This law, which went into effect on September 6, 2012, makes it illegal to drive around or through signs or traffic control devices closing a road or highway due to hazardous conditions, like flooded roadways. A conviction for violation of this law results in 2 points added to your driving record and a fine of up to \$250. Additionally, if emergency responders are called out because of your actions, the fine is increased to up to \$500 and you will be held liable for repaying the emergency response costs.

CHAPTER 6: REFERENCES

This chapter will provide a quick reference concerning helpful information, forms, publications and literature.

CUSTOMER CALL CENTER

Information regarding driver and vehicle services is available 24 hours a day if using a touch tone telephone.

Customer Service Representatives are available between the hours of 8 a.m. and 5 p.m. - Monday through Friday

For direct assistance except on major holidays: 717-412-5300 TDD: 711

ROAD TEST AND SPECIAL POINT EXAMINATION APPOINTMENTS

Appointments must be made to take the Special Point Examination and the Non-Commercial Road Test. When you are ready to take the Road Test or Special Point Examination, you may schedule your test online via the Driver and Vehicle Services website at www.dmv.pa.gov. If you do not have access to the Internet, you can schedule your test by calling 1-800-423-5542 between the hours of 8 a.m. and 5 p.m., Monday through Friday, except holidays.

Remember: If you are under 18 years of age, you may not take your Road Test for six (6) months after you have received your learner's permit and you must have completed the 65 hours of behind-the-wheel skill-building requirements.

NON-CDL THIRD PARTY TESTING PROGRAM

PennDOT has certified third-party businesses to administer the road test for a market-driven fee. All third-party examiners are PennDOT-certified and the test is identical to the test that you would take at a PennDOT driver license center. For a list of participating businesses in your area, visit www.dmv.pa.gov.

DEPARTMENTAL FORMS AND PUBLICATIONS ON THE INTERNET

Information, forms, publications and fact sheets relating to driver licensing and motor vehicles are available for customer convenience and are located on PennDOT's Driver and Vehicle Services website at www.dmv.pa.gov.

STATEWIDE AND COUNTY MAPS

For information on statewide and county maps, call 1-717-787-6746, Monday through Friday, except holidays, between the hours of 8 a.m. and 4 p.m.

OTHER INFORMATION

The United States Department of Transportation has an Auto Safety Hotline at 1-800-424-9393 or on the Internet at www.nhtsa.dot.gov.

511PA

511PA provides free, 24-hour information services including traffic delay warnings, weather forecasts, regional tourism information, and links to transit agencies and major airports. The service is available by calling 511 from cellular phones and land lines or through the internet by visiting www.511PA.com. The 511PA roadway network includes all 1,759 miles of interstate including the Pennsylvania Turnpike, as well as other major roadways in Harrisburg, Philadelphia and Pittsburgh. Traffic information for the majority of this network includes incident reports such as crashes, construction activities and winter road conditions. Additionally, average traffic speeds are available for several interstates and other major roadways in urban areas. Users are also able to register through the website to receive personalized traveler alerts, provided through e-mail and text messaging.

PennDOT encourages motorists to not call 511PA while driving. Callers should safely pull off the road to call the system, or check for travel delays before heading out.

CARBON MONOXIDE POISONING

All gas-powered vehicles produce carbon monoxide, a deadly odorless gas which is released out of the exhaust pipe of the vehicle. You cannot smell carbon monoxide gas. If you become drowsy or nauseous, it could indicate carbon monoxide poisoning.

SYMPTOMS OF CARBON MONOXIDE EXPOSURE

- Fatigue or weakness
- Dizziness
- Headache
- Nausea and/or vomiting
- Rapid heart rate
- Irregular breathing
- Confusion or disorientation
- Coughing
- Chest pain

TIPS TO PREVENT CARBON MONOXIDE POISONING IN VEHICLES

- Regular inspection and maintenance of your vehicle's exhaust system and mufflers are essential in preventing carbon monoxide poisoning in your vehicle. If you are aware of holes or other deficiencies in your exhaust system have it checked out by an automotive professional right away.
- Do not warm up your vehicle in the garage with the garage door down or partially down. Open your garage door completely if your vehicle is running in your garage.
- If your vehicle is keyless and you park it in an attached garage, never forget to turn off the vehicle.
- On snowy days, always inspect your tail pipe and remove any snow or ice that might be obstructing your vehicle's tail pipe.
- If you are stuck in traffic or otherwise sitting in an idling vehicle, make sure to partially open a window.
- Consider installing a battery operated carbon monoxide detector in your vehicle and check or replace batteries when changing the time on clocks in spring and fall each year.
- If you suspect carbon monoxide poisoning in your vehicle, exit the vehicle immediately, get fresh air, and seek emergency medical attention right away.

<u>TOPIC</u>	<u>PAGE</u>	<u>TOPIC</u>	<u>PAGE</u>
Accelerator Sticks	62	What Class Do You Need?	4
Accidents (See Crashes)		Driver’s License/Learner Permit:	
Address, Change	89	Who Needs	3
Air bag Safety Information	91	Driving at Night	39
Alcohol and Driving	33	Driving Emergencies, Dealing With:	
Alternative Testing Method	92	Accelerator Sticks	62
Americans with Disabilities Act (ADA)	91	Brake Failure	62
Appointments:		Brake Suddenly	61
Road Test	5, 94	Braking	58
Special Point Examination	94	Drifting Off Pavement	63
Backing Up	38	Flooded Roadways	61
Bicyclists	55, 56, 92, 93	Horn, Using	44
Blind Pedestrians	9	Hydroplaning	41
Blind Spots	37	Signals, Using	44
Brake Failure	62	Skidding	61
Braking	58, 60	Slippery Surfaces - Road Conditions	40
Buses	56	Snow and Ice	41
School Buses	58	Steering	60
Carbon Monoxide Poisoning	95	Tire Blowout	62
Changing Lanes	38	Vehicle Approaching Head On	64
Child Restraint Law	90	Wet Pavements	40
Circular Intersections	49	Driving Record Information	79
Classes of Driver’s Licenses	4	Driving Under the Influence (DUI)	33, 34, 81
Communicating Your Intentions to Other Drivers ..	43	Drugs and Driving	34, 81
Controlled Substance:		Emissions, Vehicle Safety Inspection	92
Driving Under the Influence (DUI)	81	Emergency Vehicles	59
Crashes	34, 81	Fleeing or Eluding Police	81
Critical Driving Errors	34	Flooded Roadways	61
Crossing Traffic	46	Fog	42
Curves, Negotiating	51	Foreign License Holders	3
Customer Call Center	94	Forms and Publications, Departmental	94
Deaf/Hearing Impaired, Interpreters for the	91	“Four-Second Rule,” The	35
Driver Factors	32	Funeral Procession	64
Alcohol and Driving	33	Guide Signs	19
Diseases and Medical Conditions	33	Headlights	39, 40
Driving Distractions	32	Headlight/Windshield Wiper Law	42
Drugs and Driving	34	Head Restraints, Adjust	32
Health Factors	33	Health Factors	33
Hearing	33	Highways and Interchanges, Negotiating:	
Inattention	32	Entering Highways	52
Lack of Sleep	32	Exiting Highways	52
Vision	33	Traveling on Highways	52
Driver’s License Compact (DLC)	84	Horn, Using Your	44
Driver’s License/Learner Permit:		Horse-Drawn Vehicle and Horse Back Riders ..	59
Classes of Driver’s Licenses	4	Hydroplaning	41
Junior Driver’s License Information	3	Inattention (How it Can Affect Your Driving) ..	32
Junior Learner’s Permit Information	3	Other Information	94
		Inspection, Vehicle Safety and Emissions	92

<u>TOPIC</u>	<u>PAGE</u>	<u>TOPIC</u>	<u>PAGE</u>
Insurance, Driving Without	80	Looking:	
Internet	92	Ahead	37
Interpreters for the Deaf/Hearing Impaired	91	Behind	38
Intersections:		To the Sides	38
Approaching Intersections	48	Managing Space	35
Jughandles	50	Managing Speed	38
Negotiating, Who Must Yield	48	Maps, Statewide and County	94
Roundabouts and Traffic Circles	50	Merging With Traffic	46
Signs & Pavement Markings for Lane Assignment	48	Military Personnel	3
Traffic Signals & Stop Signs	49	Mirrors	31
Traveling Across	49	Motorcycles/Mopeds, Sharing the Road	55
Turning Left	45, 48, 49	Name, Change in	89
Turning Right	45, 46, 48	Negotiating at Intersections	48
Interstate Route Numbering System	20	Night, Driving at	39
Junior Driver's License Information	3	Organ Donation Awareness Trust Fund	2
Junior Learner's Permit Information	3	Organ Donor Designation	2
Keeping Your Vehicle Where It Can Be Seen	37	Parking	52
Laws:		Areas for Persons with Disabilities	92
Americans with Disabilities Act (ADA)	91	Parallel Parking	6, 52, 53
Anti-Littering	92	Passing:	
Bicycle	92	In General	46, 47
Child Restraint	90	May Not	47
Safety Tips for Children and Pets	90	On a Two-Lane Road	47
Driver's License Compact (DLC)	84	On the Right	47
Driving Under the Influence of Alcohol		Pavement:	
or a Controlled Substance	81	Drifting Off The	63
Headlight/Windshield Wipers	42	Markings	22
Implied Consent (Chemical Testing for		Pedestrians	55
Alcohol or Drugs)	82	Blind	9
Insurance, Driving Without	80	Signals	9
Name or Address	89	Point Removal for Safe Driving	79
Obedience to Traffic-Control Devices Warning		Point System, Pennsylvania's	79
of Hazardous Conditions Law	93	Police, What to Do if Stopped By	80
Passengers in an Open-Bed Truck	59	Railroad Crossbuck Sign	10
Required Notification for Change in Name or Address	89	Railroad Crossings	55
Parking Areas for Persons with Disabilities	92	Railroad Crossing Signal	9
Seat Belt	89	References	94
Snow/Ice Removal	41	Regulatory Signs	10
Move Over	59	Road, Conditions:	
Texting	93	Flooded Roadways	61
Underage Drinking	84	Hydroplaning	41
Zero Tolerance (Under 21 DUI)	84	Slippery Roads/Surfaces	40, 41
Learner's Permit:		Snow and Ice	41
Applying for a Learner's Permit	1	Wet Pavements	40
Junior Learner's Permit Information	3	Road Rage, Dealing With	60
Junior Driver's License Information	3	Roundabouts	50
Learning to Drive	31	School Buses	58

<u>TOPIC</u>	<u>PAGE</u>	<u>TOPIC</u>	<u>PAGE</u>
Seat, Adjust the Driver’s	31	Suspensions and Revocations	
Seat Belt, Fasten Your	31	of Driving Privilege	79
Signaling:		Tests:	
Using Emergency Signals	44	Alternative Testing Method	92
When Changing Direction	44	If You Fail the Test	6
When Slowing Down or Stopping	43	If You Pass the Test	6
Signals (Traffic):		Knowledge	5
Flashing	8	Road	5
Lane Use Control	8	Tires:	
Lights and Arrows	7	Blowout	62, 63
Non-Functioning Traffic Lights	8	Traffic:	
Pedestrian	9	Circles, Roundabouts	50
Railroad Crossing	9	Handling Traffic Conditions One at a Time 40, 41, 42	
Ramp Metering	8	Slow Moving Traffic	43
School Zone	9	Traffic Flow	43
Signs:		Traffic Lights (See Signals)	
Guide Signs	19	Trucks:	
Exit Numbers	19	Backing Crashes	58
Highway/Expressway	19	Braking	58
Interstate Route Numbering System	20	Escape Ramps	58
Mile Markers	20	Following a Truck	57
Route Markers	21	Oversized Loads	58
Service	21	Passing a Truck	56
Tourist-Oriented Directional	21	Truck Passing	57
Regulatory Signs	10	Turns	57
Warning Signs	13	Turning, Merging, and Passing	45
Channeling Devices	19	Crossing Traffic	46
Electronic Arrow Panels	19	Left and Right Turns	45
Obedience to Traffic-Control Devices Warning		Merging with Traffic	46
of Hazardous Conditions Law	93	Passing	46
Objects Adjacent to the Roadway	17	Turning From or Into a Center Turn Lane	45
Work Zone	18	Turning Right at a Red Light	46
Skidding	61	U-Turns	46
Slippery Roads	40, 41	Underage Drinking	84
Slow-Moving Traffic, Reactions to	43	Vehicle Checks, Preparing to Drive	31
Snow-Ice Removal	41	Veterans Designation	2
Snow Plows	60	Visibility Conditions:	
Snow Squall	42	Fog	42
Social Security Number Information	3	Snow	42
Space Cushion:		Vision	3, 33
Ahead	35	Warning Signs	13
Behind	37	Wet Pavements	40, 41
“Four-Second Rule,” The	35	Winter Roads, Slick	41
To the Sides	36	Work Zones	18, 54
Speed:		Channeling Devices	19
Managing	38	Work Zone Signs	18
Posted Limits	38	Zero Tolerance Law (Under 21 DUI)	84
Move Over Law	59		
Steering	60		

They'll Never Forget The Thompsons' Party.



Neither will the Thompsons.

Because the law says any adult who gives or sells beer, wine, wine coolers or liquor to a person under 21 faces up to a year in jail, a minimum fine of \$1,000 for the first kid served and \$2,500 for each additional minor.

Giving your own son or daughter a drink is illegal, too. Before you make a mistake, call or write for our free brochure, "The Responsible Parent," and read it.

A downloadable PDF is also available online at:
http://www.lcb.state.pa.us/webapp/Education/Materials/Materials_Order_form.asp

We guarantee it's something you'll remember for a long, long time.

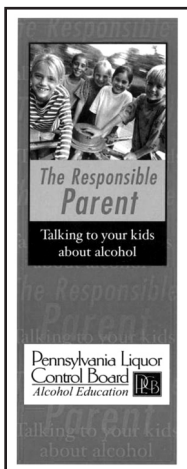

Pennsylvania Liquor
Control Board
Northwest Office Building
Harrisburg, PA 17124

Pennsylvania Chapter
American Academy of
Pediatrics

Commonwealth of
Pennsylvania
Department of Transportation

IMPORTANT WORDS TO REMEMBER

ORGAN DONOR

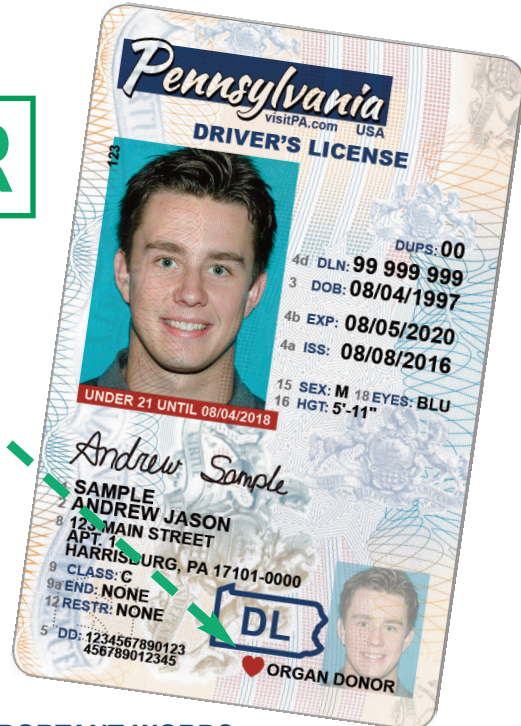

WHEN YOU GET YOUR LICENSE, REMEMBER THESE IMPORTANT WORDS

They're important words to thousands who await life-saving organ and tissue transplants. Words that could help others regain sight through cornea transplants, heal from burns more quickly with donated skin, or walk without pain with transplanted bone.

Individuals who choose to save a life by saying "yes" to organ and tissue donation should place the donor designation on the license and sign a donor card. The wish to donate also should be shared with family and friends so that they are aware of the important decision that has been made to help others.

SOME QUICK FACTS ABOUT ORGAN AND TISSUE DONATION

- One organ and tissue donor can save up to 8 lives and help more than 75 people.
- Anyone, regardless of age or medical history, can sign up to be a donor.
- All major religions in the United States support organ and tissue donation and consider donation as a final act of love and generosity toward others.
- There is no cost to donors or their families for organ or tissue donation.
- For more information visit donatelife.org

TO GET AN ORGAN AND TISSUE DONOR CARD, CALL:

In Eastern Pennsylvania:

Gift of Life Donor Program 1-888-DONORS-1

In Western Pennsylvania:

Center for Organ Recovery
& Education (CORE) 1-800-DONORS-7

For additional organ and tissue resource information, call:

PA Department of Health 1-877-PAHEALTH